



P.N.:6530-397G Rev. B

980™ Series

Owner's Manual

Sundance® Spas

Kingston™

Claremont™

Lisbon™

Odessa™

Attention New Hot Tub Owner!

Congratulations on the purchase of your new Sundance® Spas hot tub! The following is a list of automated functions performed by your hot tub. These functions are listed below in an attempt to suppress any operational concerns you may have during the first 24 hours of ownership! Also listed below are important maintenance recommendations you should observe on a regular basis to protect your new investment.

Maintain Healthy Spa Water

Always maintain your hot tub's water chemistry within the following parameters:

	With CLEARRAY®	Without CLEARRAY
pH	7.4-7.6	7.4-7.6
Free chlorine	no less than 1.0 ppm	3.0-4.0 ppm
Free Bromine	no less than 2.0 ppm	2.0-4.0 ppm
Total Alkalinity	100-150 ppm	100-150 ppm
Calcium Hardness	150-250 ppm	150-250 ppm

IMPORTANT: CLEARRAY Water Purification System is factory installed. If the CLEARRAY system is altered or is not operating efficiently follow the "without CLEARRAY" water chemistry parameters. Such parameters are defined by the Association of Pool and Spa Professionals. CLEARRAY requires an annual lamp replacement to properly sanitize your water.

 **TO DECREASE RISK OF INFECTION OR DISEASE!** Always maintain your spa filter as outlined below to ensure healthy spa water. Refer to pages 61-63 for additional information.

Required Filter Maintenance

Your new hot tub is equipped with an advanced MicroClean® Ultra water filtration system that provides unsurpassed water quality! To ensure maximum water quality at all times, you should replace the filter cartridge every six months, or earlier as necessary. The filter cartridge is designed to be thrown away! Attempts to reuse the filter cartridge may result in the re-release of unwanted particles back into the hot tub. See pages 61-63 for detailed filter cartridge replacement instructions.

Required Water Replacement

 **TO DECREASE RISK OF INFECTION OR DISEASE!** You should replace the hot tub's water every 3 to 6 months. The frequency depends on a number of variables including frequency of use, number of users, and attention paid to water quality maintenance. You will know it is time for a change when you cannot control sudsing and/or you can no longer get the normal feel or sparkle to the water, even though the key water balance measurements are all within the proper parameters. See pages 69-70 for additional information.

Table of Contents

1.0	Important Hot Tub Owner Information.....	1
2.0	FCC Notice	1
3.0	Important Safety Instructions for all Spa Owners	2
3.1	Entrapment Risk	7
3.2	Hyperthermia	8
3.3	Important Additional Safety Instructions	9
4.0	Locating Your Sundance Hot Tub	9
4.1	Outdoor Location	10
4.2	Indoor Location	11
5.0	General Electrical Safety Instructions.....	12
6.0	Electrical Installation Instructions (240V Service)	12
7.0	Power Requirements.....	16
8.0	Hot Tub Fill Up Procedure	17
9.0	Hot Tub Features	21
9.1	Claremont™ Hot Tub Features.....	21
9.2	Claremont Massage/Waterfall Selector Diagram	22
9.3	Claremont Air Controls Diagram.....	23
9.4	Kingston™ Hot Tub Features	24
9.5	Kingston Massage/Waterfall Selector Diagram	25
9.6	Kingston Air Controls Diagram	26
9.7	Lisbon™ Hot Tub Features.....	27
9.8	Lisbon Massage/Waterfall Selector Diagram	28
9.9	Lisbon Air Controls Diagram.....	29
9.10	Odessa™ Hot Tub Features.....	30
9.11	Odessa Massage/Waterfall Selector Diagram.....	31
9.12	Odessa Air Controls Diagram	32
10.0	Registration and Start-up	33
10.1	Start-up Sequence.....	33
10.2	Register Your New Spa	33
10.3	Home Menu	34
11.0	Operating Instructions	36
11.1	Activating the Jets Pumps and Blower	36
11.2	Lights Menu	37
11.3	Music Menu	40
11.4	Connecting the BLUEWAVE® System to your Bluetooth® device.....	41
11.5	Acoustics Settings Menu	42
11.6	CLEARRAY on Demand.....	43
11.7	Selecting The Desired Massage Action.....	43
11.8	Adjusting Fluidix Reflex™, Nex™, ST™, Intelli-Jet™ And Focus Relief®	43

980™ Series

11.9	Air Controls.....	44
11.10	Waterfall Control.....	44
11.11	Fragrance Dispenser.....	44
11.12	SmartTub™ System.....	45
12.0	Programming and Operation Instructions.....	47
12.1	Draining the SunCooler (Claremont and Kingston Models).....	48
12.2	Programming the Heating Mode.....	50
12.3	Programming the Primary Filtration.....	51
12.4	Programming the Secondary Filtration.....	52
12.5	Cleanup Cycle.....	53
12.6	Blow-Out Cycle.....	53
12.7	Water Care Programming.....	53
12.8	SunSmart 2.0 Wi-Fi Setup (not applicable if the optional SmartTub™ system is installed).....	56
12.9	Programming the Time and Date.....	57
12.10	Locking the Spa.....	58
12.11	Programming the Language.....	59
12.12	Units Display.....	60
12.13	System Information.....	60
13.0	Hot Tub Maintenance.....	61
13.1	Cleaning/Replacing the Filter Cartridge.....	61
13.2	Removing the cabinet panels.....	63
13.3	Draining And Refilling.....	64
13.4	Cleaning The Hot Tub Interior.....	65
13.5	Pillow Care.....	66
13.6	Maintaining the Hot Tub Cabinet.....	66
13.7	Cover Care And Maintenance.....	66
13.8	Winterizing.....	67
13.9	Restarting Your Hot Tub in Cold Weather.....	68
13.10	Synthetic Inserts.....	68
14.0	Water Quality Maintenance.....	69
14.1	pH Control.....	69
14.2	Sanitizing.....	69
14.3	CLEARRAY Water Purification System.....	70
14.4	CLEARRAY Bulb Replacement and Quartz Tube Maintenance.....	71
14.5	Other Additives.....	73
15.0	Troubleshooting - Display Messages.....	74
16.0	Troubleshooting - Procedures.....	78
17.0	Typical Hot Tub Wiring Diagrams A-B (North American 60 Hz Models Only).....	80
18.0	Circuit Board Electrical Wiring Diagram.....	81
18.1	North American 60 Hz Electrical Wiring Diagram for 2-pump models...	81
18.2	North American 60 Hz Electrical Wiring Diagram for 3-pump models...	82
18.3	North American 60Hz Dip Switch Settings.....	83

1.0 Important Hot Tub Owner Information

Your Sundance® Spa hot tub is constructed to the highest standards and is capable of providing many years of trouble-free use. However, because heat retentive materials are utilized to insulate the hot tub for efficient operation, an uncovered hot tub surface and wall fittings directly exposed to sunlight and high temperatures for an extended period are subject to permanent damage or discoloration. Damage caused by exposing the hot tub to this abuse is not covered under warranty. We recommend that you always keep the hot tub full of water when it is exposed to direct sunlight and that you keep the Sundance insulating cover in place at all times when the hot tub is not in use. Read and carefully follow the requirements for your hot tub's support base found in the Section 4.0 titled, "Locating Your Sundance Hot Tub" (page 9) or as prescribed by your authorized Sundance Spas dealer.

Sundance hot tubs constantly strives to offer the finest hot tubs available, therefore, modifications and enhancements may be made which affect the specifications, illustrations and/or instructions contained herein.

2.0 FCC Notice

This equipment has been tested and found to comply with the limits for a Class B Digital Device, pursuant to Part 15 of the FCC Rules. These limits are designed to provide reasonable protection against harmful interference in a residential installation. This equipment generates, uses and can radiate radio frequency energy and, if not installed and used in accordance with the instructions, may cause harmful interference to radio communications. However, there is no guarantee that interference will not occur in a particular installation. If this equipment does cause harmful interference to radio or television reception, which can be determined by turning the equipment off and on, the user is encouraged to try to correct the interference by one or more of the following measures:

1. Rearrange or relocate the receiving antenna;
2. Increase the separation between the equipment and receiver;
3. Connect the equipment into an outlet on a circuit different from the circuit connected;
4. Consult the dealer or an experienced radio/TV technician for help. (Changes or modifications not expressly approved by the party responsible for FCC compliance could void the user's authority to operate this equipment).

3.0 Important Safety Instructions for all Spa Owners

READ AND FOLLOW ALL INSTRUCTIONS CAREFULLY!

This spa was manufactured to meet the standards and specifications outlined in the “Virginia Graeme Baker Pool and Spa Safety Act” (VGB Safety Act). When installing and using this spa, basic safety precautions should always be followed, including:

1.  **DANGER: RISK OF SEVERE INJURY OR DROWNING!**
 - Extreme caution must be exercised to prevent unauthorized access by children.
 - To avoid accidents, ensure that children do not use this spa unless supervised at all times. Adult supervision is a critical safety factor in preventing children from drowning.
 - Use the straps and clip tie downs to secure the spa cover when not in use. This will help discourage unsupervised children from entering the spa. Keep the spa cover secure in high-wind conditions.
 - There is no representation that the cover, clip tie-downs, or actual locks will prevent access to the spa.

2.  **DANGER: RISK OF SEVERE INJURY OR DROWNING!**
 - Keep hair, loose articles of clothing or hanging jewelry away from suction fittings, rotating jets or other moving components to avoid entrapment that could lead to drowning or severe injury.
 - Never use the spa unless all suction guards, filter, filter lid, or skimmer assembly are installed to prevent body and/or hair entrapment.
 - Never operate or use the spa if the filter, filter lid, or skimmer assembly are broken or any part of the skimmer assembly is missing. Please contact your dealer or nearest service center for service.
 - The suction fittings and suction covers in this spa are sized to match the specific water flow created by the pump(s). If it is necessary to replace the suction fittings, suction covers or pump(s), be sure that the flow rates are compatible and are in compliance with the VGB Safety Act.
 - Never replace a suction fitting or suction cover with one rated less than the flow rate marked on the original suction fitting. Using improper suction fittings or suction covers can create a body or hair suction entrapment hazard that may lead to drowning or severe injury.

3.  **DANGER: RISK OF SEVERE INJURY FROM ELECTRIC SHOCK OR DEATH FROM ELECTROCUTION!**
 - Install the spa at least 5 feet (1.5m), from all metal surfaces. As an alternative, a spa may be installed within 5 feet of metal surfaces if each metal surface is permanently connected (bonded) by a minimum No. 8 AWG (8.4 mm²) solid copper conductor attached to the wire connector on the grounding lug, inside the equipment compartment on the equipment box.

- A grounding wire connector is provided on this unit to connect a minimum No. 8 AWG (8.4 mm²) solid copper conductor between this unit and any metal equipment, metal enclosures of electrical equipment, metal water pipe, or conduit within 5 feet (1.5m) of the unit.
- Never permit any electrical appliance, such as a light, telephone, radio, television, etc. within 5 feet (1.5m) of a spa unless such appliances are built-in by the manufacturer.
- Never bring any electrical appliances into or near the spa.
- Never operate any electrical appliances from inside the spa or when you are wet.
- The electrical supply for this product must include a suitably rated switch or circuit breaker to open all ungrounded supply conductors to comply with section 422-20 of the National Electrical Code/ USA, ANSI/NFPA 70. The disconnecting means must be readily accessible and visible to the spa occupant but installed at least 5 feet (1.5m), from the spa.
- The electrical circuit supplied for the hot tub must include a suitable ground fault circuit interrupter (GFCI) as required by NEC Article 680-42.

4.  **WARNING: RISK OF SEVERE INJURY OR DEATH!**

- Extreme caution must be exercised to prevent diving or jumping into the spa or slipping and falling, which could result in unconsciousness, drowning, or serious injury. Remember that wet surfaces can be very slippery.
- Never stand, walk or sit on the top railing of the spa.



5.  **WARNING: RISK OF HYPERTHERMIA (OVER-HEATING) CAUSING SEVERE INJURY, BURNS, WELTS OR DEATH!**

- Water temperature in excess of 104°F (40°C) may be injurious to your health.
- Refer to Section 3.2 Hyperthermia for specific causes and symptoms of this condition.
- The water in the spa should never exceed 104°F (40°C). Water temperatures between 100°F (38°C) and 104°F (40°C) are considered safe for a healthy adult.
- Lower water temperatures are recommended for young children (children are especially sensitive to hot water) and when spa use may exceed 10 minutes.
- The Consumer Products Safety Commission/USA has stated that the water temperature in a spa should not exceed 104°F (40°C).
- Always test the spa water temperature before entering the spa. The user should measure the water temperature with an accurate thermometer since the tolerance of water temperature-regulating devices may vary as much as +/- 5°F (2°C).

6.  **WARNING: RISK OF SEVERE INJURY OR DEATH!**
 - Since excessive water temperatures have a high potential for causing fetal damage during the early months of pregnancy, if pregnant or possibly pregnant, consult your physician before using a spa.
 - Pregnant or possibly pregnant women should limit spa water temperatures to 100°F (38°C).
 - Persons suffering from obesity or a medical history of heart disease, low or high blood pressure, circulatory system problems, diabetes, infectious diseases or immune deficiency syndromes should consult a physician before using a spa.
 - If you experience breathing difficulties in association with using or operating your spa, discontinue use and consult your physician.
 - Persons using medication should consult a physician before using a spa since some medication may induce drowsiness, while other medication may affect heart rate, blood pressure, and circulation.
 - Persons suffering from any condition requiring medical treatment, the elderly, or infants should consult with a physician before using a spa.
 - The use of alcohol, drugs, or medication before or during spa use may lead to unconsciousness with the possibility of drowning.

7.  **WARNING: RISK OF SEVERE INJURY OR DEATH!**
 - Prolonged immersion in a spa may be injurious to your health.
 - Observe a reasonable time limit when using the spa. Exposures at higher temperatures can cause high body temperature (overheating). Symptoms may include dizziness, nausea, fainting, drowsiness, and reduced awareness. These effects could possibly result in drowning or serious injury.
 - Never use a spa immediately following strenuous exercise. Enter and exit the spa slowly. Wet surfaces can be slippery.

8.  **WARNING: TO DECREASE RISK OF INFECTION OR DISEASE!**
 - To reduce the risk of contracting a waterborne illness (e.g. an infection, bacteria or virus) and/or respiratory ailments, maintain water chemistry within the parameters listed on the inside cover of this manual and consult with a licensed engineer regarding proper ventilation if installed indoors or in an enclosed area.
 - People with infectious diseases should not use a spa to avoid water contamination, which could result in spreading infections to others.
 - Always shower before and after using your spa. Maintain water chemistry in accordance with manufacturer's instructions. Failure to do so may result in contracting a waterborne illness (e.g. an infection, bacteria or virus).

9.  **WARNING:** In addition to maintenance of filters and water chemistry, proper ventilation is recommended to reduce the risk of contracting a waterborne illness (e.g. an infection, bacteria or virus) and/or respiratory ailments that could be present in the air or water. Consult a licensed architect or building contractor to determine your specific needs if installing your hot tub indoors.
10. **CAUTION: TO DECREASE RISK OF PRODUCT DAMAGE.**
 - Maintain water chemistry in accordance with manufacturer's instructions.
 - Proper chemical maintenance of spa water is necessary to maintain safe water and prevent possible damage to spa components.
11.  **WARNING: RISK OF SEVERE INJURY OR DEATH!**

The appliance is not intended for use by persons (including children) with reduced physical, sensory or mental capabilities, or lack of experience or knowledge, unless they have been given supervision or instruction concerning use of the appliance by a person responsible for their safety.
12. **NOTE:** This spa is not intended nor designed to be used in a commercial or public application. The spa buyer shall determine whether there are any code restrictions on the use or installation of this spa since local code requirements vary from one locality to another.

Hot Tub Safety Literature

To ensure you have a safe and enjoyable hot tub experience, learn all you can about hot tub safety and emergency procedures. Especially useful are the brochures listed below:

- [Children Aren't Waterproof](#)
- [Pool and Spa Emergency Procedures For Infants and Children](#)
- [Layers of Protection](#)
- [The Sensible Way to Enjoy Your Spa or Hot Tub](#)

The Association of Pool and Spa Professionals publishes these brochures. To acquire a brochure:

- Ask your hot tub dealer (they may have copies)
- Go to <http://www.apsp.org>
- Conduct your own search on the internet
- Write to the following address:

The Association of Pool and Spa Professionals
2111 Eisenhower Avenue
Alexandria VA 22314
703.838.0083

FOR CALIFORNIA RESIDENTS ONLY
NUR FÜR EINWOHNER KALIFORNIENS
POUR LES RÉSIDENTS DE LA CALIFORNIE SEULEMENT
PARA RESIDENTES DE CALIFORNIA ÚNICAMENTE



WARNING: Drilling, sawing, sanding or machining wood products can expose you to wood dust, a substance known to the State of California to cause cancer. Avoid inhaling wood dust or use a dust mask or other safeguards for personal protection. For more information go to www.p65Warnings.ca.gov/wood



ACHTUNG: Das Bohren, Sägen, Schleifen oder Zerspanen von Holzprodukten kann Stäube freisetzen. Diese Substanz gilt im US-Bundesstaat Kalifornien als krebserregend. Möglichst keinen Holzstaub einatmen bzw. eine Staubmaske oder anderweitige persönliche Schutzmaßnahmen einsetzen. Weitere Informationen finden Sie auf www.P65Warnings.ca.gov/wood



AVERTISSEMENT: Le forage, le sciage, le ponçage ou l'usinage des produits du bois peuvent vous exposer à la poussière de bois, une substance connue dans l'État de Californie pour causer le cancer. Éviter d'inhaler la poussière de bois ou utiliser un masque antipoussières ou d'autres mesures de protection personnelle. Pour de plus amples renseignements, consulter le site www.P65Warnings.ca.gov/wood



ADVERTENCIA: Perforar, cortar, lijar o usar máquinas con productos de madera le puede exponer a polvo de madera, una sustancia reconocida por el Estado de California como causante de cáncer. Evite inhalar polvo de madera o utilice una máscara antipolvo u otros resguardos para protección personal. Para más información, visite www.P65Warnings.ca.gov/wood

6530-460 Rev A (12/18)

FOR CALIFORNIA RESIDENTS ONLY
NUR FÜR EINWOHNER KALIFORNIENS
POUR LES RÉSIDENTS DE LA CALIFORNIE SEULEMENT
PARA RESIDENTES DE CALIFORNIA ÚNICAMENTE



WARNING: Cancer and Reproductive Harm
www.p65Warnings.ca.gov



ACHTUNG: Krebserregend und mit fortpflanzungsschädigender Wirkung-www.p65Warnings.ca.gov



AVERTISSEMENT: Cancer et danger pour la reproduction
www.p65Warnings.ca.gov



ADVERTENCIA: Cáncer y daño reproductivo
www.p65Warnings.ca.gov

6530-464 Rev A (12/18)

3.1 Entrapment Risk

The Consumer Products Safety Commission/USA has reported that users of pools and spas have become entrapped (stuck) to drain and/or suction fittings causing death, drowning, or serious injury (see diagram below). This spa was manufactured to meet the standards and specifications outlined in the “Virginia Graeme Baker Pool and Spa Safety Act” (VGB Safety Act). Entrapment risk can be minimized if proper precautions are taken.





DANGER: RISK OF PERSONAL INJURY OR DEATH!

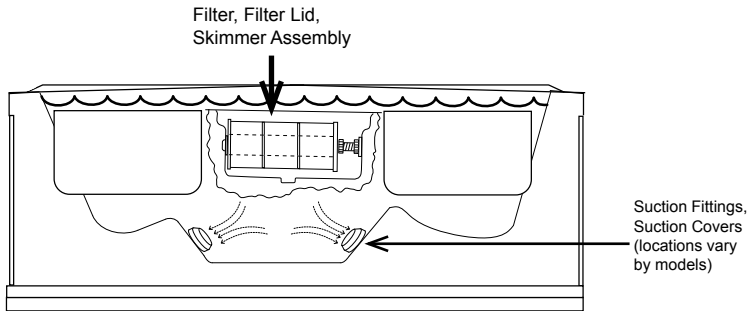

Never operate the spa if a suction fitting, suction cover, filter, filter lid or skimmer assembly are broken, damaged or missing.



NOTE: SUCTION COVERS MUST BE REPLACED EVERY 7 YEARS.

1.  **DANGER: RISK OF SEVERE INJURY OR DROWNING!**
Hair entrapment: May occur if hair is entangled, knotted or snagged in a drain suction or skimmer assembly. This has been reported in persons who when submerge themselves underwater, allowing hair to come close and/or within the reach of the suction fittings, suction covers or skimmer assembly.
 - Keep hair away from suction fittings, suction covers, filter, filter lid or skimmer assembly.
 - Children are at risk for hair entrapment if swimming under water.
 - Never allow children to play or get near the suction fittings, suction covers, filter, filter lid or skimmer assembly.

2.  **DANGER: RISK OF SEVERE INJURY OR DROWNING!**
Limb entrapment: May occur when a limb becomes entrapped, inserted or sucked into a suction or outlet opening.
 - Always keep suction fittings, suction covers, filter, filter lid or skimmer assembly in place when operating to avoid limb entrapment.
 - Never allow children to play or get near the suction fittings, suction covers, filter, filter lid or skimmer assembly.

3.  **DANGER: RISK OF SEVERE INJURY OR DROWNING!**
Body entrapment: May occur when part of the torso becomes entrapped, inserted or sucked into a suction or outlet opening.
 - Never allow children to play or get near the suction fittings, suction covers, filter, filter lid or skimmer assembly.
4.  **DANGER: RISK OF SEVERE INJURY OR DROWNING!**
Evisceration (disembowelment) entrapment: May occur when the buttocks becomes entrapped, inserted or sucked into a suction or outlet opening.
 - Never sit on suction fittings, suction covers, filter, filter lid or skimmer assembly.
 - Never allow children to play or get near the suction fittings, suction covers, filter, filter lid or skimmer assembly.
5.  **DANGER: RISK OF SEVERE INJURY OR DROWNING!**
Mechanical entrapment: May occur when jewelry, swimsuit, or hair accessories become entangled, knotted or snagged in a drain suction or skimmer assembly.
 - Never allow your jewelry, swimsuit, or hair accessories to come close to the suction fittings, suction covers or skimmer assembly.
 - Never allow children to play or get near the suction fittings, suction covers, filter, filter lid or skimmer assembly.

3.2 Hyperthermia

Prolonged immersion in hot water may induce hyperthermia (overheating). The use of alcohol or drugs can greatly increase the risk of fatal hyperthermia in spas. A description of the causes, symptoms, and effects of hyperthermia are as follows:

Hyperthermia occurs when the internal temperature of the body reaches a level several degrees above the normal body temperature of 98.6°F (37°C). The symptoms of hyperthermia include drowsiness, lethargy (fatigue), and an increase in the internal temperature of the body (feeling of being too hot). The effects of hyperthermia include:

- Unawareness of impending hazard;
- Failure to perceive heat;
- Failure to recognize the need to exit spa;
- Physical inability to exit spa;
- Fetal damage in pregnant women; and
- Unconsciousness and danger of drowning.

A Warning Sign is provided in your warranty packet. Please install at a location near your spa, where it is visible to users of the spa. For additional or replacement Warning Signs please contact your local Sundance spas dealer and reference item number #6530-082.

3.3 Important Additional Safety Instructions

When using this electrical equipment, basic safety precautions should always be followed, including the following:

1. **READ AND FOLLOW ALL INSTRUCTIONS.**
2. A green colored terminal or a terminal marked G, Gr, Ground, Grounding or the  symbol* is located inside the supply terminal box or compartment. To reduce the risk of electric shock, this terminal must be connected to the grounding means provided in the electric supply service panel with a continuous copper wire equivalent in size to the circuit conductors that supply this equipment (*IEC Publication 417, Symbol 5019).
3. At least two lugs marked “Bonding Lugs” are provided on the external surface or on the inside of the supply terminal box/compartment. To reduce the risk of electric shock, connect the local common bonding grid in the area of the spa to these terminals with an insulated or bare copper conductor not smaller than No. 6 AWG (10 mm²).
4. All field installed metal components such as rails, ladders, drains or other similar hardware within 10 feet (3m) of the spa shall be bonded to the equipment grounding buss with copper conductors not smaller than No. 6 AWG (10 mm²).
5. **SAVE THESE INSTRUCTIONS.**

4.0 Locating Your Sundance Hot Tub

IMPORTANT: Because of the combined weight of the spa, water and users, it is extremely important that the base upon which the spa rests be smooth, flat, level and capable of uniformly supporting this weight, without shifting or settling, for the entire time the spa is in place. Visit www.SundanceSpas.com for weight information. If the spa is placed on a surface which does not meet these requirements, damage to the skirt and/or the spa shell may result. Damage caused by improper support is not covered under warranty. It is the responsibility of the spa owner to assure the integrity of the support over time. We recommend a poured, reinforced concrete slab with a minimum thickness of 4 inches (10 cm). Wood decking is also acceptable provided it is constructed so that it meets the requirements outlined above.



WARNING: For spas that are to rest on balconies, roofs or other platforms not specifically tied into main structural support, consult a professional Structural Engineer with experience in this type of application.



WARNING: Proper drainage is required. The installation must not allow the spa equipment bay to become flooded or wetted (by external water). It is your responsibility, and the responsibility of any installation contractor you hire, to make sure that all applicable codes and/or local construction requirements are met. If in doubt, refer to the building authority responsible for approving the proposed installation site.

The spa must be installed in such a manner as to provide drainage away from it. Placing the spa in a depression without provisions for proper drainage could allow rain, overflow, leaks from spa plumbing, and other casual water to flood the equipment and create a wet condition in which it would sit in. For spas which will be installed below grade or recessed into a floor or deck, install so as to permit access to the equipment, either from above or below, for servicing. Make certain that there are no obstructions which would prevent removal of all side cabinet panels and access to components, especially on the side with the equipment bay doors.



CAUTION: If the spa is indoors or located in an enclosed area, proper ventilation should be discussed with an Engineer or authority competent enough to understand the necessary provisions needed to vent moist or heated air and air associated with chemical odors outdoors. **When the spa is in use considerable amounts of moisture will escape potentially causing mold and mildew.** This can cause health risk. Over time, this can damage certain surfaces, surroundings, and equipment.

4.1 Outdoor Location

In selecting the ideal outdoor location for your hot tub, we suggest that you take into consideration the following:

- The proximity to changing area and shelter (especially in regions subject to cold weather).
- The pathway to and from your hot tub (this should be free of debris so that dirt and leaves are not easily tracked into the hot tub).
- The closeness to trees and shrubbery (remember that leaves and birds could create extra work in keeping the hot tub clean).
- A sheltered environment (less wind and weather exposure can result in lowered operation and maintenance costs).
- The overall enhancement of your environment. It is preferable not to place the hot tub under an unuttered roof overhang since run-off water will shorten the life expectancy of the hot tub cover.
- For spas that are to rest on balconies, roofs or other platforms not specifically tied into main structural support, consult a professional Structural Engineer with experience in this type of application.
- In the unlikely event that you should ever need to access or gain entry to any portion of the spa for servicing, it is highly recommended that you plan your outdoor installation to provide full access to the entire spa. Please take this into consideration when placing the spa in a deck or enclosed by a surrounding.

- Consider locating your spa away from any reflective surface or glass to prevent any damage to the synthetic skirt.
- Do not shim the spa. To ensure proper support the spa must sit flat on the intended foundation.

4.2 Indoor Location

For indoor installations many factors need to be considered before installing a spa indoors:



WARNING: In addition to maintenance of filters and water chemistry, proper ventilation is recommended to reduce the risk of contracting a waterborne illness (e.g. an infection, bacteria or virus) and/or respiratory ailments that could be present in the air or water. Consult a licensed architect or building contractor to determine your specific needs if installing your hot tub indoors.

- **PROPER FOUNDATION:** Consult a Structural Engineer when considering a foundation that will adequately support the spa the entire time it is in place. Proper support is critical especially if the spa is to rest on a second story or higher. For spas that are to rest on balconies, roofs or other platforms not specifically tied into the main structural support, you should consult a professional Structural Engineer with experience in this type of application.
- **PROPER DRAINAGE:** It is extremely important to have in place measures to sufficiently handle excessive water spillage. Be sure the flooring in which the spa rests on has adequate drainage and can handle draining of the entire contents of the spa. Be sure to make provisions for ceilings or any other structures that may be below the spas installation. Areas around your spa can become wet or moist so all flooring and subsequent furniture, walls and adjacent structures should be able to withstand or resist water and moisture.
- **PROPER VENTILATION:** Proper ventilation should be discussed with an Engineer or authority competent enough to understand the necessary provisions needed to vent moist or heated air and air associated with chemical odors outdoors. When the spa is in use considerable amounts of moisture will escape potentially causing mold and mildew, over time this can damage certain surfaces and or surroundings.
- **SUFFICIENT ACCESS:** In the unlikely event that you should ever need to access or gain entry to any portion of the spa for servicing, it is highly recommended that you plan your indoor installation to provide full access to the entire spa.
- **WARRANTY:** Damage caused by not following these guidelines or any improper installation not in accordance with local codes or authorities is not covered under the spas warranty. Please consult your local state or city building ordinances.
- **DO NOT SHIM THE SPA.** To ensure proper support the spa must sit flat on the intended foundation.

5.0 General Electrical Safety Instructions

Your new Sundance Spas hot tub is equipped with the “state-of-the-art” equipment system. It contains the most advanced safety and self-protective equipment in the industry. Nonetheless, this hot tub must be installed properly to ensure dependable usage. Please contact your local Sundance Spas dealer or local building department should you have any questions regarding your installation.



Proper grounding is extremely important. Sundance hot tubs are equipped with a current collector system. A pressure wire connector is provided on the surface of the control box, located inside the equipment door (Figure C, page 15) to permit connection of a bonding wire between this point and any ground metal equipment, metal water pipe or conduit within 5 feet (1.5m) of the hot tub, or copper clad grounding rod buried within 5 feet (1.5m) of the hot tub. Bonding wire must be at least No. 8 AWG (8.4 mm²) solid copper wire. This is a most important safety assurance feature.

Before installing your hot tub, check with your local government/electrical authority to ensure installation conforms to local country/area state codes.

6.0 Electrical Installation Instructions (240V Service)

IMPORTANT NOTICE: The electrical wiring of this hot tub must meet the requirements of the National Electrical Code (NEC) and/or any applicable state, local or country codes. The electrical circuit must be installed by a qualified electrician and approved by a local building/electrical inspection authority in your state or country.



1. **DANGER: TO DECREASE THE RISK OF SHOCK, PRODUCT DAMAGE OR ELECTRICAL FIRE.**

This hot tub must be permanently connected (hard-wired) to the power supply. **No plug-in connections or extension cords are to be used in conjunction with the operation of this hot tub.**

Supplying power to the hot tub which is not in accordance with these instructions will void both the independent testing agency listing and the manufacturer's warranty.

2. The power supplied to this hot tub must be a dedicated circuit with no other appliances or lights sharing the power provided by the circuit.
3. To determine the current, voltage and wire size required, refer to Section 7.0 (page 16) for your specific hot tub model.
 - Wire size must be appropriate per NEC and/or local/country codes.
 - The spa controller's terminal block will accept a maximum wire size of 6 AWG.

4. The electrical supply for this product must include a suitably rated switch or circuit breaker to open all ungrounded supply conductors to comply with Section 422-20 of the National Electrical Code, ANSI/NFPA 70. The disconnecting means must be readily accessible and visible to the hot tub's occupant but installed at least 5 feet (1.5m) from the hot tub.
5. The electrical circuit supplied for the hot tub must include a suitable ground fault circuit interrupter (GFCI) as required by NEC Article 680-42.
6. An appropriate size breaker must be used depending on the model, see chart on page 16. The electrical supply for this product must include a suitably rated isolating switch and circuit breaker to comply with local electrical regulations. This RDC/GFCI circuit breaker must be installed at the power supply in the house electrical box.
7. Select the power supply entrance you want to use (Figure B, page 14) and remove the cabinet panel from the front of the hot tub, then feed cable through the large opening provided on the bottom of the control box.
8. To gain access to the hot tub's power terminal block you will need to remove the front corner and center cabinet, (Figure A, page 14). These cabinets are located under the synthetic top deck panels.
9. Grab one of the corner panels, from the bottom, and gently pull the cabinet forward to unsnap it from the holding clip. Then slide it down to remove. Place the panel in a safe location to prevent from damaging it. Repeat the steps to remove the other corner panel, Figure A, page 14.
10. Remove the center panel. Grab either the top left or top right side of the front center panel. Gently pull the cabinet forward to unsnap it from the holding clips. Make sure to support the cabinet as you work your way down the side to completely unclip it from the hot tub frame. Once completely unclipped, tilt slightly forward and lift up to remove it from the hot tub frame, Figure A, page 14.
11. Connect wires, color to color, on terminal blocks TB1 and TB3 (page 15). **TIGHTEN SECURELY!** All wires must be hooked up securely or damage could result.
12. Install the control box door and reinstall the cabinet panel(s).

Figure A

Remove Corners
(unclip bottom
first)

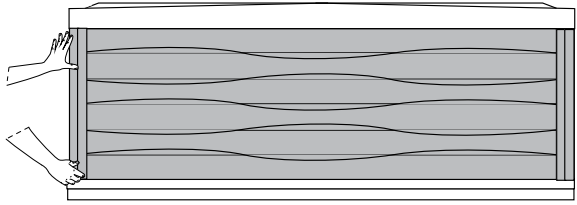

Unclip across
the top

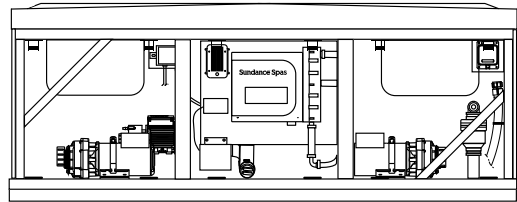
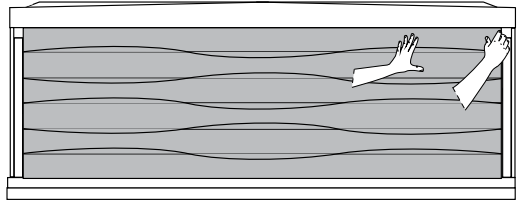
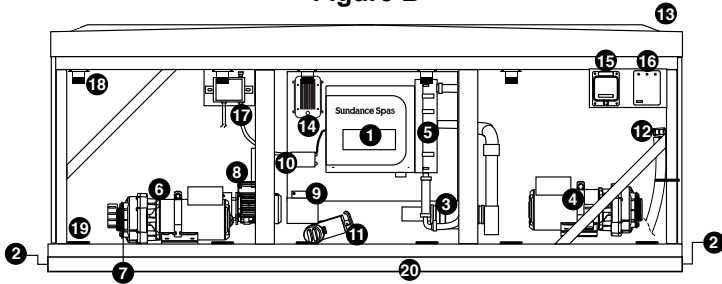

Figure B



Note: Equipment location (such as pumps, CLEARRAY® system, drain, heater etc.) varies by model.

- | | |
|---|--|
| 1. Control Box | 12. Hot Tub Drain |
| 2. Power Supply Entrance(s) | 13. Control Panel |
| 3. Blower | 14. BLUEWAVE® 2.0 Wireless Audio System (Optional) |
| 4. Jets Pump | 15. SmartTub™ system |
| 5. Heater | 16. Bridge (with SmartTub™ system) |
| 6. Jets Pump | 17. CLEARRAY PRO ₃ TECT™ (Optional) |
| 7. Pump Drain Plug(s) | 18. Cabinet Mounting clips |
| 8. Filter/Circulation Pump | 19. Cabinet Mounting slot |
| 9. CLEARRAY (Ultraviolet) Water Purification System | 20. ABS Pan |
| 10. CLEARRAY Water Purification System Ballast | |
| 11. Quick Drain™ | |

Figure C
Control Box

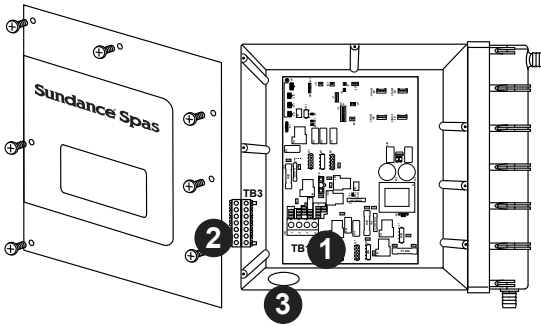

1. Terminal Block
2. Bonding Lug
3. Electrical Wires Entrance

Figure D
Terminal Block 240V
60Hz Wire Connection

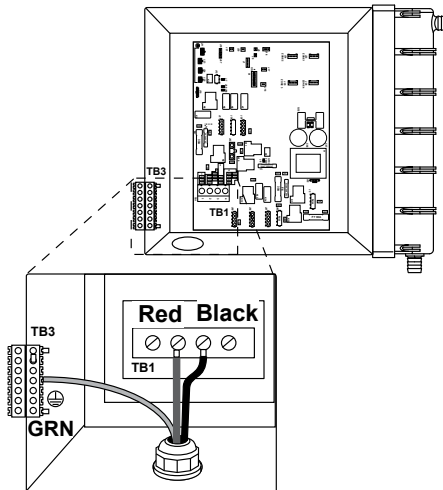

7.0 Power Requirements

Sundance Spas hot tubs are designed to provide optimum performance and flexibility of use when connected to their maximum electrical service. However, they are shipped factory configured for their most common preferred electrical connection.

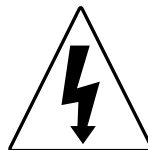

If you prefer, a qualified technician can perform a minor circuit board modification that allows the hot tub to operate on a different electrical

North American 60 Hz

Voltage	240 VAC	240 VAC	240 VAC
Max. Current Draw:			
2-Pump System	28A	39A	48A
3-Pump System	N/A	39A	48A
Frequency:	60 Hz	60 Hz	60 Hz
Number of Wires:	3	3	3
Circuit Breaker (2-Pole):	40A*	50A**	60A***

* In the 40A configuration, the heater **will not operate** while any jets pump is running. ***Not recommended for the Claremont and Kingston.***

** In the 50A configuration, the heater **will operate** when one jets pump is running, but **will not operate** while two jets pumps are running. **This is the factory default setting for a 2-pump system.**

*** In the 60A configuration, the heater **will operate** while two jets pumps are running, but **will not operate** if three jets pumps are running. **This is the factory default setting for a 3-pump system.**

8.0 Hot Tub Fill Up Procedure

For best results, read each step in its entirety before proceeding with that step. Make sure all drains are closed before you begin.

1. Prepare The Hot Tub For Filling

- Clear all debris from the hot tub. (Although the hot tub shell has been polished at the factory, you may want to treat it with a specially formulated hot tub cleaner.) Consult your dealer for additional information prior to filling hot tub.
- If using the primary filter fitting to fill, remove filter cover, then remove filter cartridge as outlined in Section 13.1, page 61.

IMPORTANT: In most cases, filling the spa by placing the hose in the footwell will not create an airlock, page 64. If you experience an airlock we recommend filling by placing the end of your garden hose into the primary filter fitting inlet.

2. Fill Hot Tub

- Place the end of your garden hose into the empty primary filter fitting or into the footwell.

CAUTION: TO DECREASE BUILD UP ON COMPONENTS AND MINIMIZE ACRYLIC DAMAGE.

Never fill with water from a water softener. If your water is extremely “hard,” it is preferable to fill half-way with hard water and the rest of the way with softened water. Water that is too soft can be corrosive to metal components.

-  **WARNING: TO DECREASE RISK OF INFECTION OR DISEASE.**
Fill hot tub with clean tap water from garden hose, to reduce risk of contracting a waterborne illness (e.g. an infection, bacteria or virus) and/or respiratory ailments. Fill until water covers all jets but does not touch the bottom of the lowest headrest. (DO NOT OVERFILL!)

3. Turn On Power

Turn on power to hot tub at the home’s circuit breaker to start-up sequence, page 33. The heater and filter/circulation pump will automatically activate.

4. Activate Jets Pumps

Turn on all jet(s) pumps and blower to ensure proper mixing when adding start up chemical in step 5.



5. Add Start-Up Chemicals

Add the hot tub water chemicals as recommended by your Sundance Spas dealer. See Section titled “Water Quality Maintenance” (page 69) for general guidance.

**WARNING: RISK OF POISONING OR DEATH.**

Never leave chemicals opened and accessible to anyone. Use chemicals according to the vendors instructions. Always store chemicals in a safe and/or locked location. Keep away from and out of reach of children.

6. Establish A Stable Sanitizer Reading

Establish a stable sanitizer reading no less than 1.0 ppm free chlorine or 2.0 ppm bromine. To ensure healthy water conditions, always maintain a constant sanitizer reading within the levels recommended on the inside cover of this manual.

7. Set Hot Tub To Heat

To warm hot tub water to a comfortable temperature, follow these steps:



- The LCD display on the control panel displays the actual temperature of the hot tub water. Press either the **COOLER** (⊖) or **WARMER** (⊕) button once to display the “set” temperature for 5 seconds. If you want the water to heat to a different temperature, simply press **COOLER** or **WARMER** within 5 seconds. The set temperature increases or decreases by 1°F (0.5°C) each time either button is pressed.
- The heater will turn off when the temperature corresponding to the thermostat setting is achieved.

Important Heater Details:

- The maximum temperature for which the hot tub can be set is 104°F (40°C) and the minimum is 65°F (18.33°C).
- For hot tubs powered with a 40 amp service, turn off jets pump #1 and jets pump #2 to operate heater.
- Setting the thermostat at maximum will not accelerate the heating process. This will only result in a higher ultimate temperature.
- The heater operates until the water reaches the programmed “set temperature,” then turns off. The heater will reactivate after the water cools to approximately 2°F (1°C) below the “set temperature.”

8. Place Cover On Hot Tub

- Keeping the insulating cover in place anytime the hot tub is not in use will reduce the time required for heating, thereby minimizing operating costs.
- The time required for initial heat-up will vary depending on the starting water temperature.

**DANGER: RISK OF PERSONAL INJURY.**

Check water temperature carefully before entering hot tub! Excessive water temperature can cause burns, welts and body temperature to rise, hyperthermia (over-heating).

Decontamination Procedure (Steps 9-15)

Steps 9-15 below are only required when sanitizer levels are unstable after performing steps 1-6 above. Disregard steps 9-15 below if sanitizer levels remain stable after performing steps 1-6 above (refer to the inside cover of the manual).

Note: The “decontamination procedure” steps 9-15 should also be used after the hot tub has been “Winterized” (Section 13.8) or has been sitting without power for an extended period.

9. Add 2.5 ounces (71 g.) of sodium dichlor for every 100 gallons (378 L.) of water. Refer to the table (below) for approximate water fill capacity by model.

	<p>CAUTION: RISK OF PERSONAL INJURY OR SPA DAMAGE!</p> <p>Never add chlorine tablets (trichlor) or acid to your hot tub for any reason! These chemicals may damage components within your hot tub, burn or irritate your skin, create a rash, and void the manufacturer warranty for your spa.</p>
---	---

Water Fill Volume

Model	Average Fill Volume*	Sodium Dichlor
Claremont.....	405 Gal (1,533 L)	10 oz
Kingston.....	401 Gal (1,518 L)	10 oz
Lisbon.....	371 Gal (1,404 L)	9 oz
Odessa.....	341 Gal (1,291 L)	8.5 oz

*Use average fill volume for chemical maintenance

10. Leave hot tub cover open during this step to allow excessive chemical vapors to exit hot tub, protecting pillows and plastic knobs from chemical attack. If hot tub is indoors, open doors and windows for proper ventilation. Turn on all hot tub jets pumps for one hour, open all air controls, turn on the blower, and place all massage selector knob(s) in their center “combo” position as shown (right).



Note: You will need to press the jets pump button(s) and blower button every 20 minutes since these functions have an automatic 20 minute time-out function that turns them off.

	<p>WARNING: RISK OF PERSONAL INJURY!</p> <ul style="list-style-type: none"> • To decrease the risk of injury, drowning or entrapment, never leave your hot tub unattended for any reason while the cover is open and accessible, especially to small children and animals! • Precautions should be taken to minimize your exposure to chemical vapors (that could cause lung, brain, or skin damage).
---	--

11. Turn off power to the hot tub at the circuit breaker, then drain tub as outlined in Section 13.3 (page 64).

12. Refill hot tub with clean tap water from garden hose until water covers all jets but does not touch the bottom of the lowest headrest. (DO NOT OVERFILL!)

CAUTION: TO DECREASE BUILD UP ON COMPONENTS AND MINIMIZE ACRYLIC DAMAGE.

Never fill with water from a water softener. If your water is extremely “hard,” it is preferable to fill half-way with hard water and the rest of the way with softened water. Water that is too soft can be corrosive to metal components.

13. Consult your authorized Sundance Spas dealer for chemical recommendations, then add chemicals to hot tub water to achieve a constant sanitizer reading within the levels recommended on the inside cover of this manual.
14. Turn on all jet pumps and the blower when adding chemicals to ensure proper mixing and leave your hot tub cover open until the sanitizer level becomes stable to protect pillows and plastic knobs from chemical attack. Refer to the inside cover of the manual.



WARNING: RISK OF PERSONAL INJURY.

- To decrease the risk of injury, entrapment or drowning, never leave your hot tub unattended for any reason, especially if while the cover is open and accessible to small children and animals!
- To decrease the risk of contracting a waterborne illness (e.g. an infection, bacteria or virus) and/or respiratory ailments, maintain water chemistry within 6 step parameters. If you or other bathers experience such a condition, discontinue use and seek immediate medical attention.

15. Establish a sanitizer reading no less than 1.0 ppm free chlorine or 2.0 ppm bromine, then allow the hot tub to set undisturbed for 8 hours. Retest water after 8 hours to determine if sanitizer levels are stable. If sanitizer levels are stable, your hot tub is ready for use. To ensure healthy water conditions, always maintain a constant sanitizer reading within the levels recommended on the inside cover of this manual. If sanitizer levels are not stable at this time, it will be necessary to repeat this procedure in its entirety (steps 1-15) until stable sanitizer readings are achieved.

IMPORTANT: If the **CLEARRAY** water purification system is removed from the hot tub or is not operating efficiently follow the “without **CLEARRAY**” water chemistry parameters. Such parameters are defined by the Association of Pool and Spa Professionals.

16. After adequate sanitizer levels are achieved, close all spa air controls by rotating them clockwise to maximize heat retention when spa is not in use.

9.0 Hot Tub Features

9.1 Claremont™ Hot Tub Features

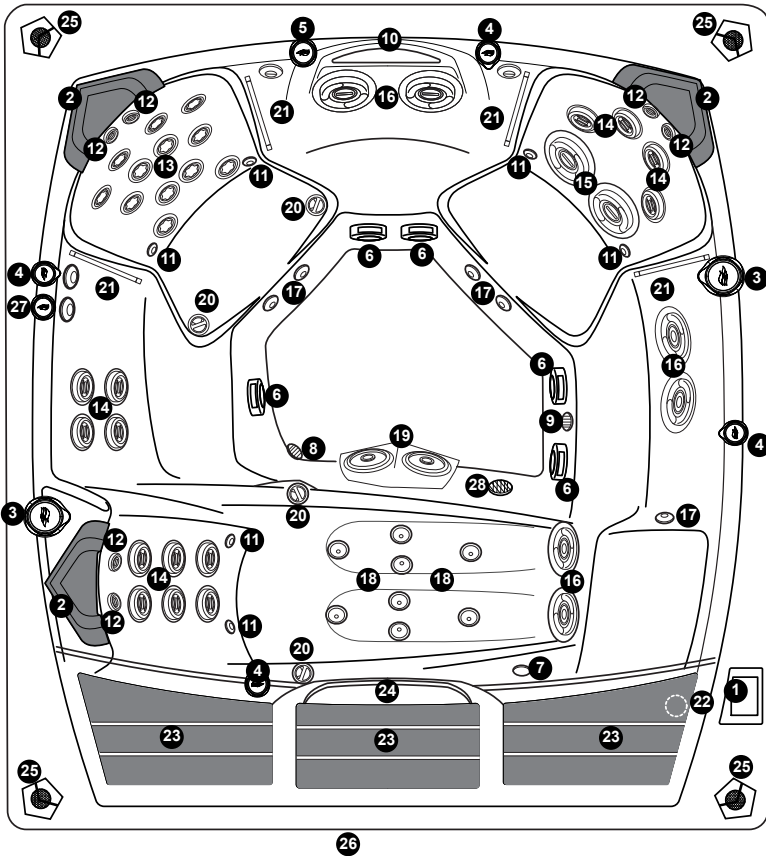

- | | |
|---|---|
| 1. Main Control Panel | 16. Vortex™ Jets (6 ea.) |
| 2. Pillows (3 ea.) | 17. Accu-Pressure™ Jets (5 ea.) |
| 3. Massage Selectors (2 ea.) | 18. Focus Relief® Jets (8 ea.) |
| 4. Air Controls (4 ea.) | 19. Whirlpool Jets (2 ea.) |
| 5. Waterfall Control Valve | 20. Pulsator™ Jets (4 ea.) |
| 6. Suction Covers (6 ea.; one is not shown) | 21. Seat Accent Lights (4 ea.) |
| 7. Light | 22. Sunscents™ Dispenser |
| 8. Waterfall Filtration Return | 23. SunCooler™ Lids |
| 9. Gravity Drain | 24. Weir Gate/Skimmer |
| 10. Waterfall | 25. Optional Audio System Speakers (4 ea.) |
| 11. Air Injectors (6 ea.) | 26. Optional BLUEWAVE® 2.0 Wireless Spa Stereo (behind cabinet) |
| 12. Fluidix Nex™ Jets (6 ea.) | 27. Accu-Ssage Seat™ Valve |
| 13. Fluidix ST™ (12 ea.) | 28. Accu-Ssage Seat™ Dump Port |
| 14. Fluidix Reflex™ Jets (14 ea.) | |
| 15. Fluidix Intelli-Jet™ (2 ea.) | |

Spa features subject to change without notice.

9.2 Claremont Massage/Waterfall Selector Diagram

Massage Selector Operation

Rotate Massage Selectors 1 and 2 to divert water between designated jet groups.

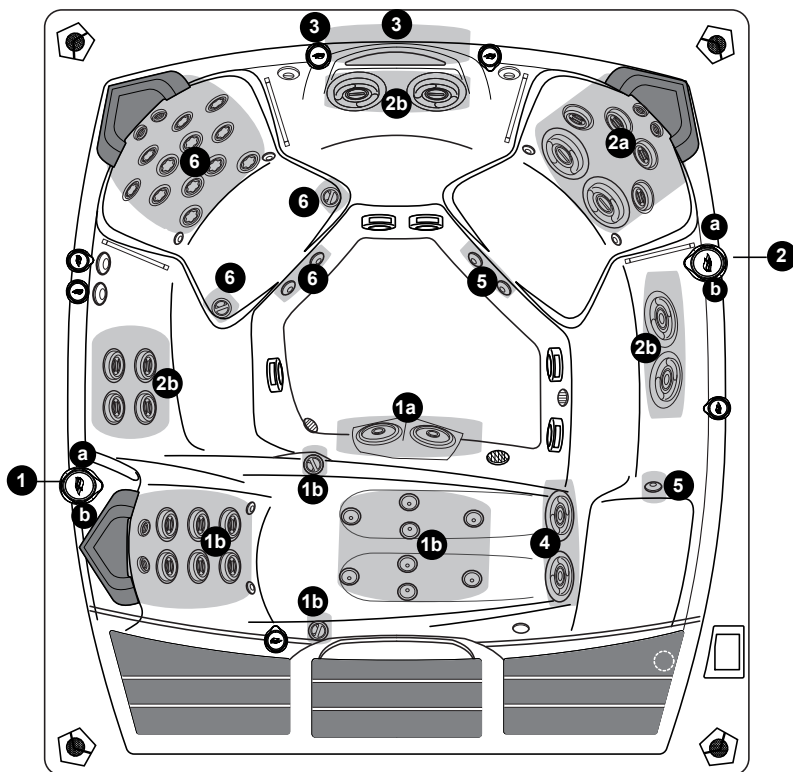

Massage Selectors (1-2)

- Massage Selector #1 controls pump #2.
- Massage Selector #2 controls pump #1.

Waterfall Selector (3)

- Waterfall Selector #3 controls circulation pump output to waterfall.

Continuously Powered Jets

- Jets #4 are always on when jets pump #2 is running.
- Jets #5 are always on when jets pump #1 is running.
- Jets #6 are always on when jets pump #3 is running.

Spa operation subject to change without notice.

9.3 Claremont Air Controls Diagram

Air Control Operation

Rotate Air Controls 1-4 to add air to designated jet groups.
Turn the Blower on to add air to jets group 5. Jet 6 connects to the Sun-Cooler perimeter drains (always on with pump 1).

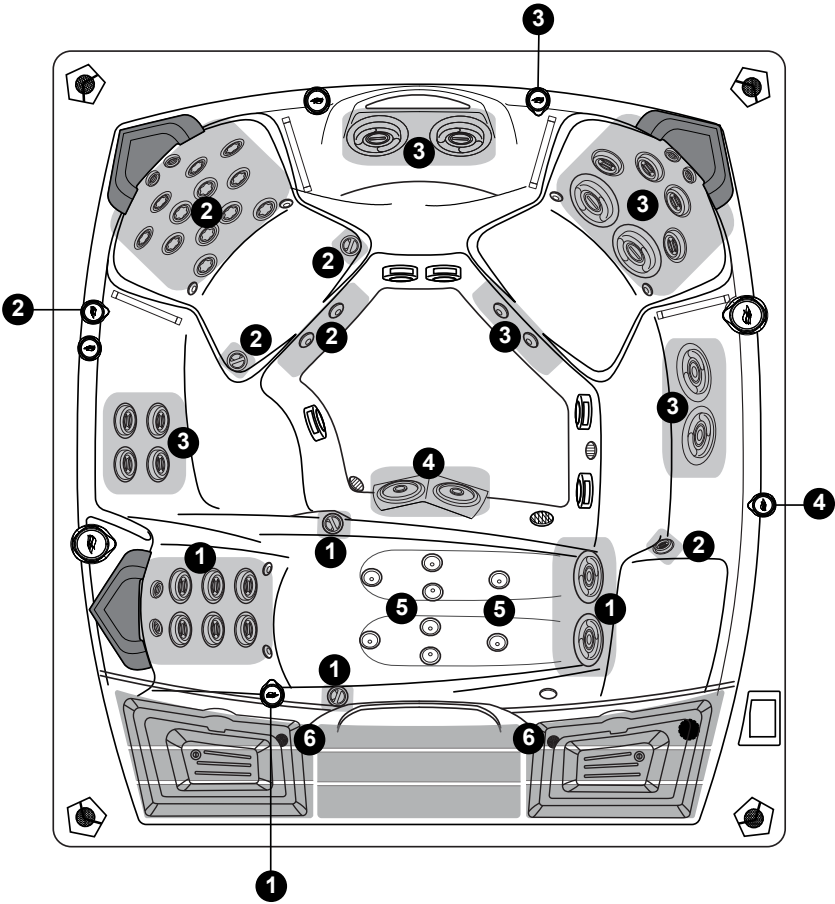

Spa operation subject to change without notice.

9.4 Kingston™ Hot Tub Features

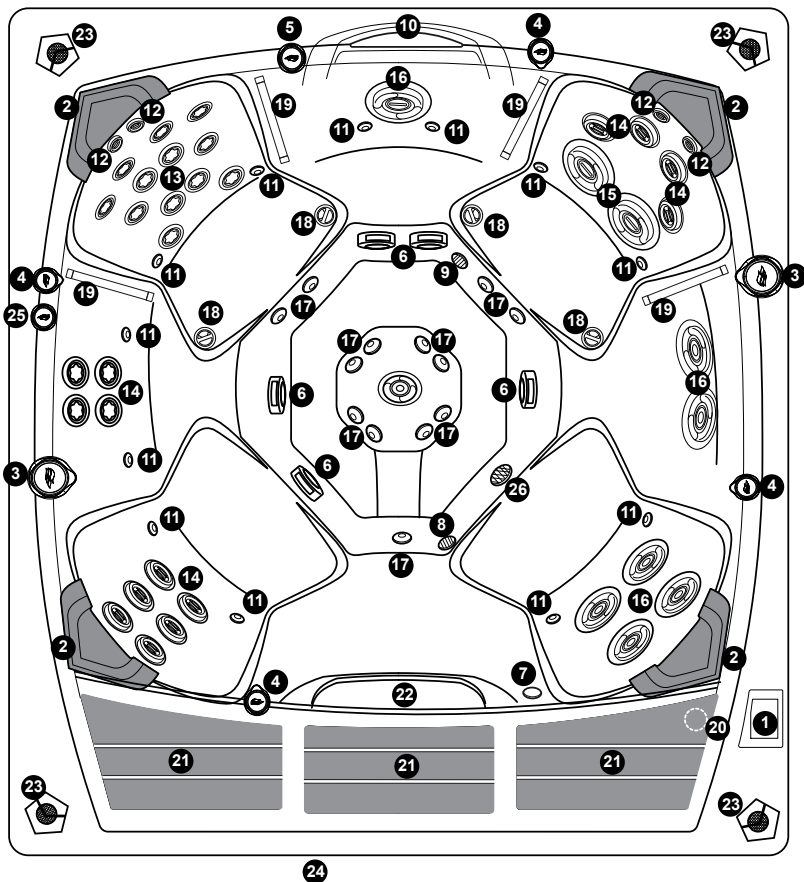

- | | |
|---|---|
| 1. Main Control Panel | 15. Fluidix Intelli-Jet™ (2 ea.) |
| 2. Pillows (4 ea.) | 16. Vortex™ Jets (8 ea.) |
| 3. Massage Selectors (2 ea.) | 17. Accu-Pressure™ Jets (13 ea.) |
| 4. Air Controls (4 ea.) | 18. Pulsator™ Jets (4 ea.) |
| 5. Waterfall Control Valve | 19. Seat Accent Lights (4 ea.) |
| 6. Suction Covers (6 ea.; one is not shown) | 20. Sunscents Dispenser |
| 7. Light | 21. SunCooler Lids |
| 8. Gravity Drain | 22. Weir Gate/Skimmer |
| 9. Waterfall Filtration Return | 23. Optional Audio System Speakers (4 ea.) |
| 10. Waterfall | 24. Optional BLUEWAVE® 2.0 Wireless Spa Stereo (behind cabinet) |
| 11. Air Injectors (12 ea.) | 25. Accu-Ssage Seat™ Valve |
| 12. Fluidix Nex™ Jets (4 ea.) | 26. Accu-Ssage Seat™ Dump Port |
| 13. Fluidix ST™ Jets (12 ea.) | |
| 14. Fluidix Reflex™ Jets (14 ea.) | |

Spa features subject to change without notice.

9.5 Kingston Massage/Waterfall Selector Diagram

Massage Selector Operation

Rotate Massage Selectors 1 and 2 to divert water between designated jet groups.

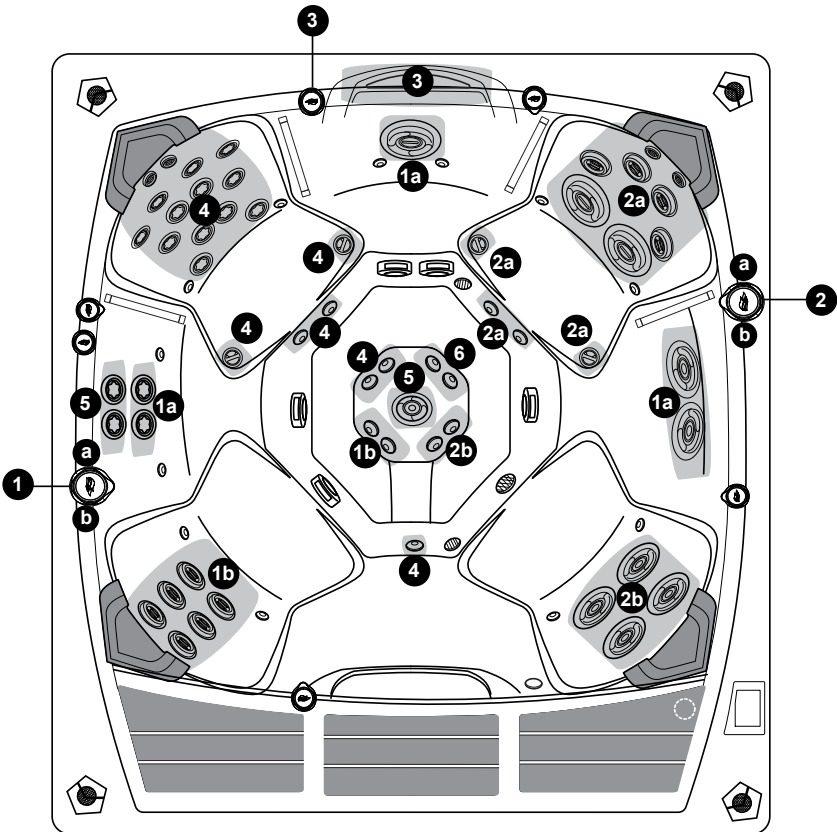

Massage Selectors (1-2)

- Massage Selector #1 controls pump #2.
- Massage Selector #2 controls pump #1.

Waterfall Selector (3)

- Waterfall Selector #3 controls circulation pump output to waterfall.

Continuously Powered Jets

- Jets #4 are always on when jets pump #3 is running.
- Jets #5 are always on when jets pump #2 is running.
- Jets #6 are always on when jets pump #1 is running.

Spa operation subject to change without notice.

9.6 Kingston Air Controls Diagram

Air Control Operation

Rotate Air Controls 1-4 to add air to designated jet groups. Jet 5 connects to the SunCooler perimeter drains (always on with pump 1).

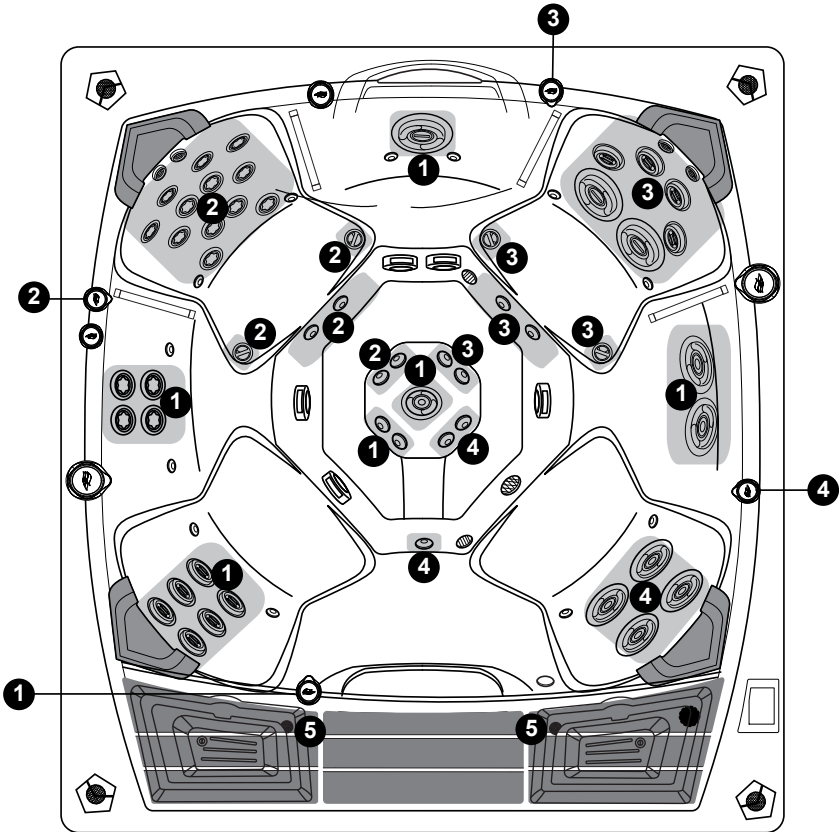

Spa operation subject to change without notice.

9.7 Lisbon™ Hot Tub Features

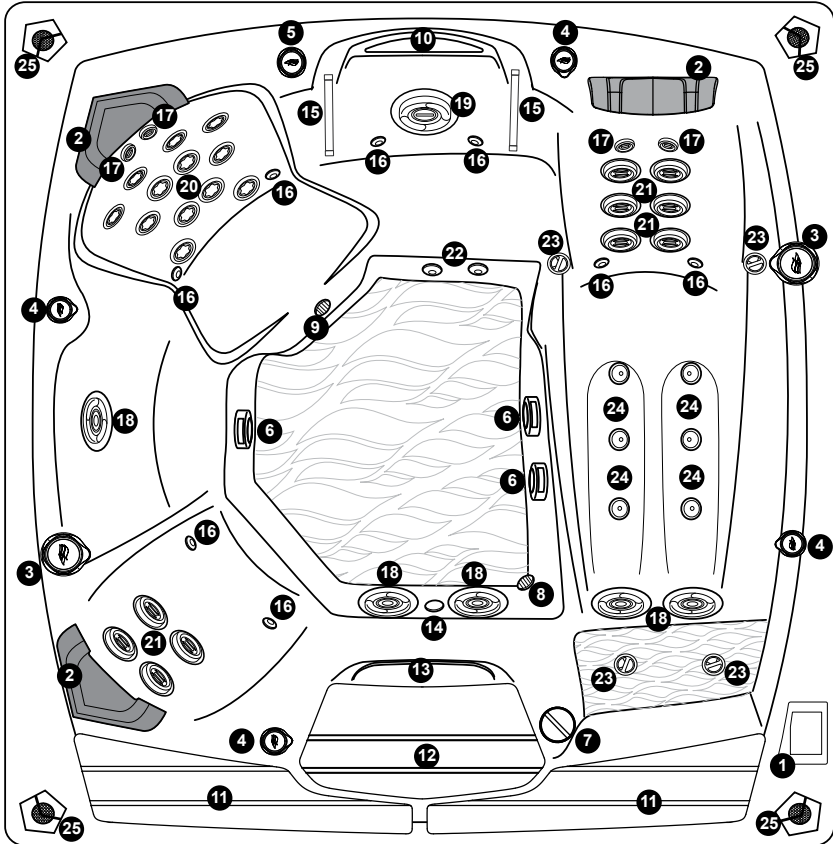

26

- | | |
|---|---|
| 1. Main Control Panel | 15. Seat Accent Lights (2 ea.) |
| 2. Pillows (3 ea.) | 16. Air Injectors (8 ea.) |
| 3. Massage Selectors (2 ea.) | 17. Fluidix Nex™ Jets (6 ea.) |
| 4. Air Controls (4 ea.) | 18. Vortex™ Jets (5 ea.) |
| 5. Waterfall Control Valve | 19. Fluidix Intelli-Jet™ (1 ea.) |
| 6. Suction Covers (4 ea.; one is not shown) | 20. Fluidix ST™ Jets (12 ea.) |
| 7. Sunscents Dispenser | 21. Fluidix Reflex™ Jets (8 ea.) |
| 8. Gravity Drain | 22. Accu-Pressure™ Jets (2 ea.) |
| 9. Waterfall Filtration Return | 23. Pulsator™ Jets (4 ea.) |
| 10. Waterfall | 24. Focus Relief Jets |
| 11. Deck Inserts | 25. Optional Audio System Speakers (4 ea.) |
| 12. SunCooler Lid | 26. Optional BLUEWAVE® 2.0 Wireless Spa Stereo (behind cabinet) |
| 13. Weir Gate/Skimmer | |
| 14. Light | |

Spa features subject to change without notice.

9.8 Lisbon Massage/Waterfall Selector Diagram

Massage Selector Operation

Rotate Massage Selectors 1 and 2 to divert water between designated jet groups.

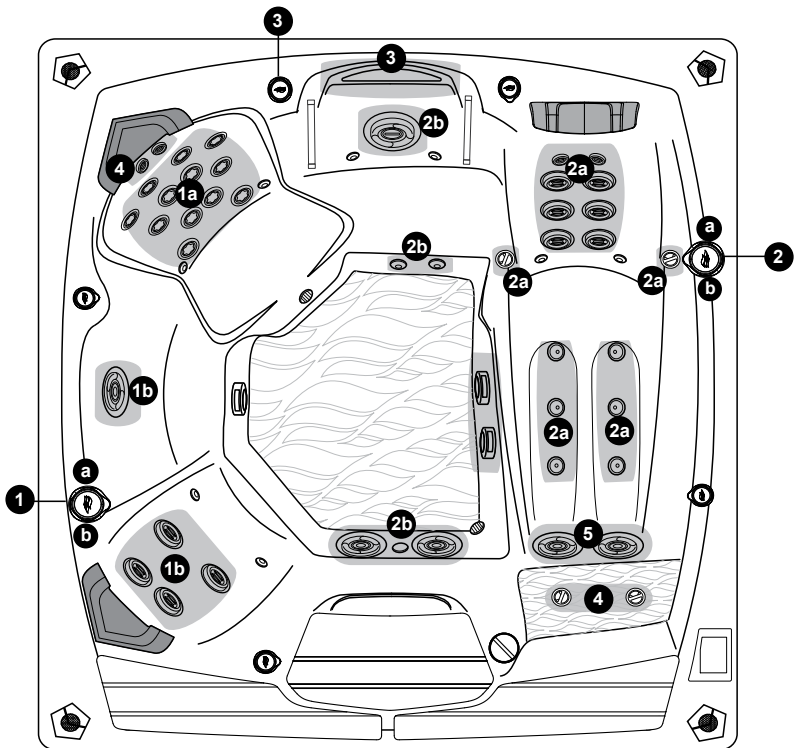

Massage Selectors (1-2)

- Massage Selector #1 controls pump #2.
- Massage Selector #2 controls pump #1.

Waterfall Selector (3)

- Waterfall Selector #3 controls circulation pump output to waterfall.

Continuously Powered Jets

- Jets #4 are always on when jets pump #2 is running.
- Jets #5 are always on when jets pump #1 is running.

Spa operation subject to changewithout notice.

9.9 Lisbon Air Controls Diagram

Air Control Operation

Rotate Air Controls 1-4 to add air to designated jet groups. Turn the Blower on to add air to jets group 5.

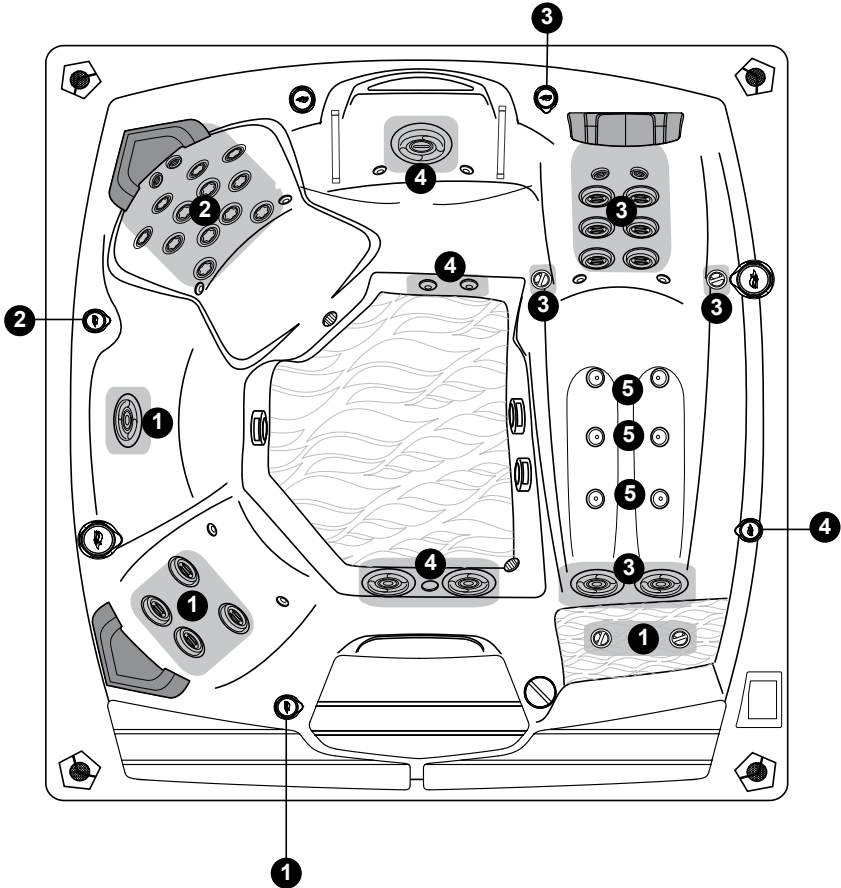

Spa operation subject to change without notice.

9.10 Odessa™ Hot Tub Features

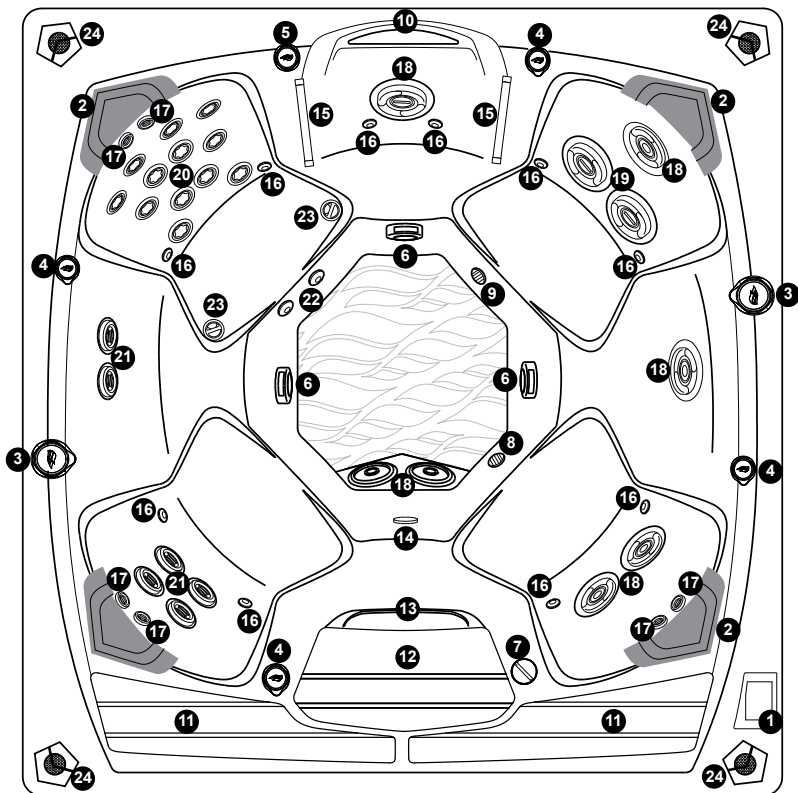

25

- | | |
|---|--|
| <ol style="list-style-type: none"> 1. Main Control Panel 2. Pillows (4 ea.) 3. Massage Selectors (2 ea.) 4. Air Controls (4 ea.) 5. Waterfall Control Valve 6. Suction Covers (4 ea.; one is not shown) 7. Sunscents Dispenser 8. Gravity Drain 9. Waterfall Filtration Return 10. Waterfall 11. Deck Inserts 12. SunCooler Lid 13. Weir Gate/Skimmer 14. Light | <ol style="list-style-type: none"> 15. Seat Accent Lights (2 ea.) 16. Air Injectors (10 ea.) 17. Fluidix Nex™ Jets (6 ea.) 18. Vortex™ Jets (7 ea.) 19. Fluidix Intelli-Jet™ (2 ea.) 20. Fluidix ST™ Jets (12 ea.) 21. Fluidix Reflex™ Jets (6 ea.) 22. Accu-Pressure™ Jets (2 ea.) 23. Pulsator™ Jets (2 ea.) 24. Optional Audio System Speakers (4 ea.) 25. Optional BLUEWAVE® 2.0 Wireless Spa Stereo (behind cabinet) |
|---|--|

Spa features subject to change without notice.

9.11 Odessa Massage/Waterfall Selector Diagram

Massage Selector Operation

Rotate Massage Selectors 1 and 2 to divert water between designated jet groups.

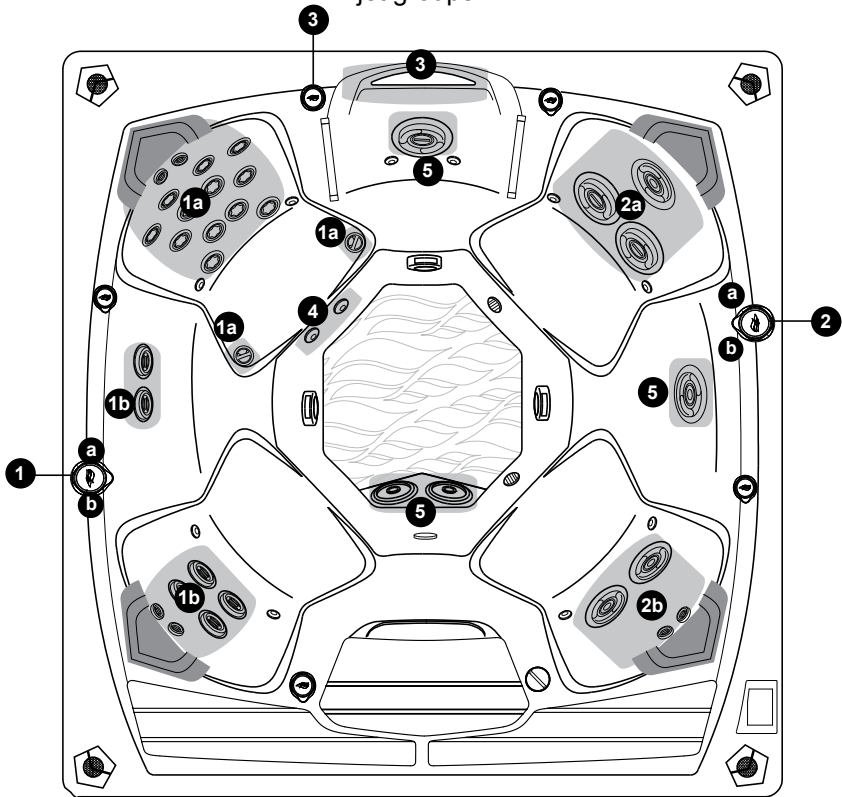

Massage Selectors (1-2)

- Massage Selector #1 controls pump #2.
- Massage Selector #2 controls pump #1.

Waterfall Selector (3)

- Waterfall Selector #3 controls circulation pump output to waterfall.

Continuously Powered Jets

- Jets #4 are always on when jets pump #2 is running.
- Jets #5 are always on when jets pump #1 is running.

Spa operation subject to change without notice.

9.12 Odessa Air Controls Diagram

Air Control Operation

Rotate Air Controls 1-4 to add air to designated jet groups.

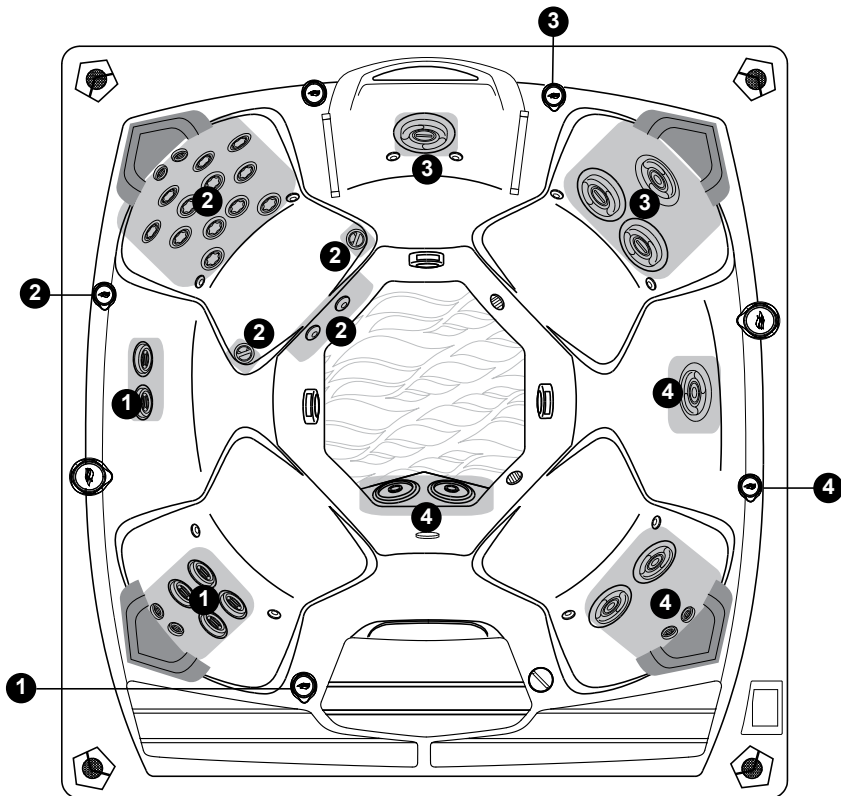

Spa operation subject to change without notice.

10.0 Registration and Start-up

10.1 Start-up Sequence

During the start-up sequence, the welcome screens will appear, Figure 10.1a. Then a blow out cycle will begin, page 53. After the cycle ends, the hot tub will display the Home Menu.

Note: The start-up menu will time out after approximately 3 seconds and then change to the Home Menu (page 34).



Figure 10.1a

10.2 Register Your New Spa

Registering your spa is important in order to validate your warranty. In order to register you will need to have the spa serial number, Figure 10.2a. The best time to retrieve the serial number is when the spa is being connected. You must register your spa via the internet at www.SundanceSpas.com.

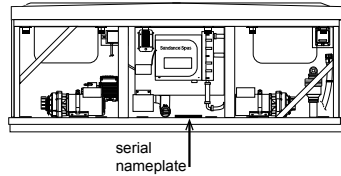

Figure 10.2a

Follow these steps to register your spa.

1. Using your home computer or other device, connect to the internet.
2. Go to www.SundanceSpas.com website to register your spa.
3. Click **Owner**
4. Click **Warranty Registration**
5. Enter your serial number.
6. Click **Next** to continue to complete your registration.

Keep a record of your serial number for any future reference. Write that information below.

Serial Number: _ _ _ _ _

10.3 Home Menu

The new iTouch™ Glass system makes operating your spa a breeze. With vivid color graphics that make operation simple and interactive. You can navigate through the menus and sub-menus with ease. Simply touch the icons on the LCD display to begin operating your new Sundance Spas hot tub. The Home Menu, Figure 10.3a, provides access to spa functions and programming. Operation is made easy by the interactive control panel.

Note: If there is no activity for 5 minutes, the LCD display, will time-out into a sleep mode. To reactivate the display, just tap and then swipe the display screen, Figure 10.3b.



Figure 10.3a



Figure 10.3b

A. Home Menu Control Buttons



= **Temperature Control:** Allows you to adjust the set temperature of the spa:



- Increase the temperature by tapping ⊕ in 1° increments.
- Decrease the temperature by tapping ⊖ in 1° increments.

Note: The temperature range for the spa is 65 to 104°F (18.33 to 40°C). To activate the **Extended Temperature feature** that allows the spa to reach 106°F (41°C), see page 77.



= **Jet Button:** Tap to access the menu to operate the jets pumps, page 47.



= **CLEARRAY Button:** Tap to activate the CLEARRAY on demand feature, page 43.



= **Light Button:** Tap to access the menu to operate the lighting options, page 37.



= **Settings Button:** Tap to access the programming and setting menus, page 47.



= **Music Button:** Tap to access the menu to operate the audio system and settings, page 40.

Note: If the spa does not have the stereo option, there will not be a button on the control panel.



= **Error Indicator Icon:** Displays when there is an error message that needs to be addressed. The icon will also appear at the Home Menu as a reminder, page 74. Tap to view the condition that requires attention.



= **Back Button:** Tap to go back a menu.



= **Invert Button:** Tap to invert the display image in 1 of 3 layouts, Figure 10.3c.



Figure 10.3c



= **Heater ON icon:** Will display when the heater is on.



= **Lock Button:** Displays when one of the lock modes is enabled, page 58.



= **Wi-Fi icon:** Will display when the Wi-Fi feature is on, page 56 (not applicable if the optional SmartTub™ system is installed).

6:45 = **Time Indicator:** The time will always be shown when the Home Menu is displayed. The appearance will vary depending on whether the clock is set to a 12-Hour or 24-Hour configuration, page 57. The default setting is 12-Hour.

Note: The time does NOT automatically adjust for daylight saving time. The time must be manually adjusted.

11.0 Operating Instructions

Your Sundance Spas hot tub has a touch-sensitive control panel, massage selector valves, and air control knobs located on the top rim of the hot tub (Sections 9.1-9.12, pages 21-32). These controls let you operate many of the special functions of your Sundance hot tub. By familiarizing yourself with the following information, you will be able to gain the full benefits afforded by the various functions of your hot tub.

11.1 Activating the Jets Pumps and Blower

From the Home Menu, (Figure 11.1a), tap  to enter the Submenu. The panel will display the Jets Pump Submenu (Figure 11.1b).

Note: Once you enter the Jets Pump Submenu, all the pumps will activate. You can turn off the jets pump by tapping the jets pump button.

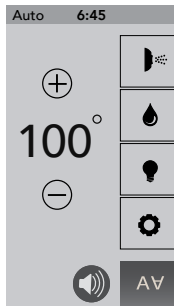

Figure 11.1a

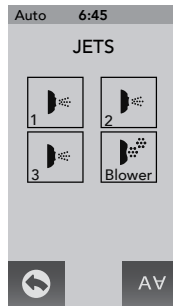

Figure 11.1b

3-Pump Menu shown



= **Jets Pump 1 Button**



= **Jets Pump 2 Button**



= **Jets Pump 3 Button (if equipped)**



= **Blower Button**



= **Back Button:** Tap to go back to the Home Menu.

A. Jets Pumps

1. Tap the Jets 1 button to turn the pump on and off.
2. Tap the Jets 2 button to turn the pump on and off.
3. Tap the Jets 3 button to turn the pump on and off, if equipped.

Note: Anytime a pump has been manually turned on, it will automatically turn off after approximately 20 minutes. If at this time you desire more jet operation you may simply turn the pump(s) back on.

B. Air Injection

Tap  to turn the blower on and off. The air blower forces air through the injectors and Focus Relief Jets. The blower automatically turns off after 20 minutes.

11.2 Lights Menu

From the Home Menu, (Figure 11.2a), tap  to enter the Light submenus. The LCD screen will display the Light Submenu (Figure 11.2b). From this menu you can control the hot tub lighting.

Note: The interior lights automatically turn off after 2 hours. They can be reactivated if needed.

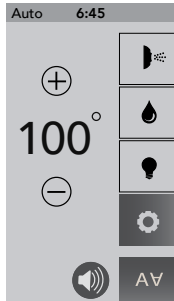

Figure 11.2a

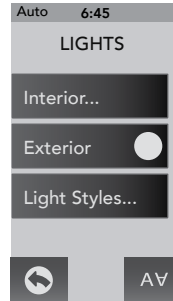







Figure 11.2b

 = Tap to enter the Interior Lights Menu.

 = Tap  to operate the Exterior Lights.

 = Tap to enter the Light Styles Menu.

 = **Back Button:** Tap to go back a menu.

 = **Invert Button:** Tap to invert the display image.

A. Interior Lights Menu

From the Lights Submenu, (Figure 11.2b), tap **Interior...** to enter the interior lights control menu. The LCD screen will display the Light Submenu (Figure 11.2c). From this menu you can control the hot tub's interior lighting. When you enter the control menu the lights will be off.

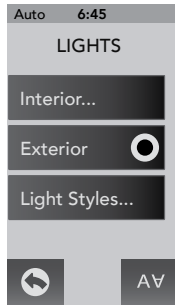

Figure 11.2b

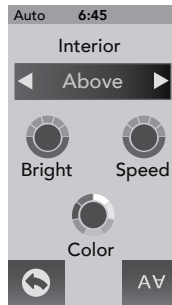
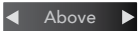

Figure 11.2c



= Controls the waterfall light. Press one of the arrows to move back and forth from above, below or all.



= Controls the entry and seat accent lights.



= Controls both the waterfall, entry, and seat accent lights.



Intensity Control Button: Press to activate and adjust the intensity of the lights. The range is from 0 to 5. To turn off the lights, the intensity level must be decreased to 0. This feature can be used for both the interior lights and light styles.

Note: Default intensity setting when activated is 5.

- Tap the button to lower the intensity of the lights to the minimum level of 0. The intensity levels are as follows:
5 = 100%, 4 = 80%, 3 = 60%, 2 = 40% and 1 = 20%,
0 = 0%.



Blending Control Button: Controls the blending speed for the lights. This feature can be used for both the interior lights and light styles.

Note: Default blending speed setting when activated is 5.

- Tap the button to lower the blending speed, of the colors, to the minimum speed of 0. The speed settings are as follows:
5 = every 5 secs, 4 = every 10 secs, 3 = every 15 secs,
2 = every 30 secs and 1 = every 60 secs.



Color Selector: Tap to select a single color. Continually press to move through the colors in a clockwise rotation.

Note: Default color is white.

B. Exterior Lights Menu

From the Lights Submenu, (Figure 11.2b), tap **Exterior** to control the SunCooler™ (if equipped) and exterior lights. The lights display a solid white color only. By continually tapping you will scroll through the following:

Note: The exterior lights automatically turn off after 8 hours, except for the timer setting.

- Lights are off.
- Lights are low intensity.
- Lights are high intensity.
- Lights are on a timer; On at 7PM and Off at 12AM everyday. Default intensity is high.

C. Lights Styles Menu

From the Lights Submenu, (Figure 11.2b), tap **Light Styles...** to enter the Light Styles control menu (Figure 11.2d). From this menu you can activate 1 of the 6 lighting styles. When you enter the submenu the lights will be off. Tap one of the words to start your lighting effect experience.



Figure 11.2b



Figure 11.2d

Warm: A rotating blend of warm colors, such as red, orange, yellow, green, and white.

Calm: A rotating blend of all the colors in a low intensity level.

Soft: A gradual color rotation of all the colors.

Cool: A rotating blend of cool colors, such as blue, violet, cyan, red, and white.

Party: A rapid rotation of all colors.

Cheer: A variant blending and rotation of all the colors.

11.3 Music Menu

Models equipped with the optional Audio System offer an enhanced spa experience. The BLUEWAVE® 2.0 Wireless Audio System works with most Bluetooth® wireless devices. An auxiliary device can be connected, via a 3.5 mm plug cable, located behind the front cabinet panel, if a Bluetooth device is not available. These models also include four high fidelity spa engineered speakers for unsurpassed sound quality and long-life, and an integrated powered subwoofer for a superb acoustical sound.

Note: If the spa does not have the stereo option, there will not be an icon () on the control panel.

To access the Music Menu, tap  , Figure 11.3a. The display will change to Figure 11.3b. Once you enter the Music Menu, tap the power button to turn the stereo on. Your connected electronic device, Bluetooth or Auxiliary, provides the audio entertainment.



WARNING: RISK OF ELECTRICAL SHOCK HAZARD EXISTS AND EQUIPMENT DAMAGE! Never install or remove electrical devices while hands are wet or while sitting partially immersed or fully immersed in spa!

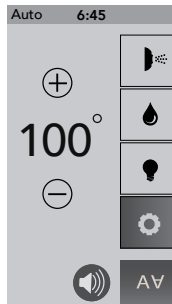

Figure 11.3a

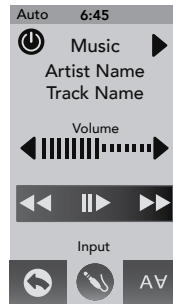

Figure 11.3b



= **Power Button:** Tap to turn the stereo on and off.



= **Bluetooth® Settings:** Tap to use a Bluetooth device with the stereo. A Bluetooth device must be connected in order for the icon to appear.



= **Auxiliary Settings:** Tap to use an Auxiliary device with the stereo. Default setting.



= **Forward:** Tap to advance forward through tracks.





= **Rewind:** Tap to move back through tracks.



= **Pause/Play:** Tap to pause and play tracks.

 = **Acoustic Settings:** Tap to access the audio submenu, page 42.

 = **Back Button:** Tap to go back to the Home Menu.

 = **Invert Button:** Tap to invert the display image.

Artist Name = **Artist/Track:** Will display the artist and track information, if it is available. If the information is not available this part will be blank. If the information provided is too long, the maximum number of characters will be display follow by dots (“...”).

Track Name

 = **Volume:** Tap to increase (▶) or decrease (◀) the volume. The range is from 0 to 15.

11.4 Connecting the BLUEWAVE® System to your Bluetooth® device

A. To bridge a connection between the BLUEWAVE 2.0 Wireless Audio System and your Bluetooth device, follow the steps below.

Note: The BT icon cannot be selected manually. It will appear when a Bluetooth connection is established with your device. If you experience a connection problem with your Bluetooth device, make sure that the Bluetooth antenna is secure and located at the highest point within the equipment bay.

1. Tap the music icon on the control panel screen then tap the power button.
2. From your Bluetooth device, make sure that the Bluetooth setting is ON.
3. Follow the pairing instructions for your Bluetooth device and connect to the “BLUEWAVE” device that appears on your screen.
4. Once the connection is established, the Bluetooth icon () on the screen will be display confirming the connection.
5. If asked for a password, enter the password “0000” and then tap “Pair” on your device to connect.
6. If the pairing process is successful, your Bluetooth device will show “Connected” right next to “BLUEWAVE.”

B. Connecting an Auxiliary Device

1. Remove the front panel.
2. Locate the BLUEWAVE unit in the equipment bay.
3. Locate the cable labeled “AUX” that is connected to the unit.
4. Use a 3.5 mm cable (not included) to connect your auxiliary device.
5. Run the cable safely, through the front, and reinstall the panel.

Note: Use caution in handling the auxiliary device, the placement of the device, and that the cable is not in the way.

11.5 Acoustics Settings Menu

To enter the Acoustics Control Menu, tap  from the Music submenu, Figure 11.5a. The display will change to Figure 11.5b. The Acoustics Control Menu offers an enhanced audio experience by providing custom or preset listening settings.

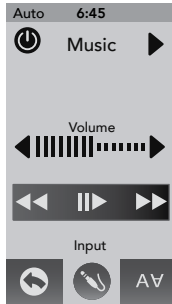



Figure 11.5a





Figure 11.5b



= **Bass Adjustment Bars:** Tap  or  to adjust the Bass range from 0 to 10. This feature can be used to create a custom sound.



= **Treble Adjustment Bars:** Tap  or  to adjust the Treble range from 0 to 10. This feature can be used to create a custom sound.

Rock

= **Rock Preset:** Tap to activate the “Rock” music audio setting. “Rock” has a 8 Bass and 6 Treble preset setting.

Pop

= **Pop Preset:** Tap to activate the “Pop” music audio setting. “Pop” has a 3 Bass and 4 Treble preset setting.

Classical

= **Classical Preset:** Tap to activate the “Classical” music audio setting. “Classical” has a 6 Bass and 6 Treble preset setting.

Podcast

= **Podcast Preset:** Tap to activate the “Podcast” audio setting. “Podcast” has a 2 Bass and 8 Treble preset setting.



= **Back Button:** Tap to go back to the Music Menu.

AV

= **Invert Button:** Tap to invert the display image.

11.6 CLEARRAY on Demand

The CLEARRAY on demand feature activates the water purification system. Continuously tap  to activate the system for 1 hour, 2 hours, 3 hours or OFF. During this time the circulation pump and the CLEARRAY unit are on.

Note: When the CLEARRAY system is on due to a programmed or scheduled setting the feature cannot be turned off.

11.7 Selecting The Desired Massage Action

Your Sundance Spas hot tub is equipped to allow you to customize the massage action you desire. Each model incorporates a massage selector(s) that allows you to customize the massage and performance by diverting water between various jet systems. Simply turn massage selector to position A (Combo), B, or C to divert water pressure to various jet groups.

Note: This valve is designed to operate in positions A (Combo), B, and C for optimum performance. It is considered normal for sound levels within the valve to vary between positions due to the large amounts of water flowing through it. For optimum filtration benefits, leave the valve in position A when hot tub is covered. Select position B or C for maximum jet performance during hot tub use.



11.8 Adjusting Fluidix Reflex™, Nex™, ST™, Intelli-Jet™ And Focus Relief®

The jets in your new hot tub offer the advantage of no moving parts and zero maintenance. They can also be adjusted for a high and low impact massage, providing the ultimate massage! To adjust jets:

1. Fluidix Nex/Intelli-Jets and Reflex Jets only: Turn outer dial (A) clockwise to increase water volume. Turn outer dial counterclockwise to decrease water volume or to shut jet off.
2. Fluidix Intelli-Jet only: Rotate center “mode disk” (B) clockwise to select a non-oscillating water stream or turn counterclockwise to select an oscillating stream at any angle.
3. For a high impact massage, turn corresponding air control knob clockwise. For the Fluidix ST™ jet, this will create a straight water flow. For low impact massage, turn corresponding air control knob counterclockwise. For the Fluidix ST™ jet, this will create an oscillating flow. Refer to Sections 9.1-9.12 (pages 21-32) for specific operation details. The included tool (shown) allows you to position the jet nozzle angle to your liking. This tool can also be used to aid in the opening or closing of the nozzle on Fluidix Reflex jets.
4. Focus Relief Jets: Work with both the blower and jets pump. The blower introduces air to the jet and the jets pump forces water through.

Note: Always keep at least 6 adjustable jets open at all times on each jet system.



Fluidix Intelli-Jet



Fluidix Reflex Jet



Fluidix ST Jet



Focus Relief Jet

11.9 Air Controls

Each jet system has its own air control. These controls allow you to regulate the amount of air which is mixed with the water entering through the jets. Clockwise rotation adds more air and counter-clockwise rotation reduces air flow.



Note: To minimize heat loss, close all air controls when spa is not in use. Certain jets may draw air even though they are closed. This is considered normal.

11.10 Waterfall Control

Turn waterfall control valve counterclockwise to increase waterfall(s) output. Turn control valve clockwise to decrease or turn off waterfall(s) output. The waterfall is on when the circulation pump is running.



Note: It takes 2 full revolutions to change the waterfall from a full off to a full on flow rate. When the waterfall is in the OFF position some water may still flow through. This is considered normal.

11.11 Fragrance Dispenser

Located under the lid, of the right hand SunCooler, is the “SunScents™ Fragrance Dispenser” (pages 21 and 32). It is designed to contain packages of a specially made fragrance available from your Sundance Spas dealer. The fragrance is carried into the hot tub water by the air coming through the injector system when the air blower is on.



WARNING: TO DECREASE RISK OF PERSONAL INJURY.

- Always turn off the air blower before removing or installing SunScents dispenser cap to reduce the risk of by having the dispenser and/or cap fly up.
- Use only Sundance SunScents fragrances in your new hot tub, as the tub has not been tested for use with any other manufacturer. Never use this dispenser for any other type of fragrance.
- Never remove the SunScents beads from their plastic cage for any reason! This can cause damage to the spa equipment and plumbing lines.
- **The beads can also be ingested creating a choking or poisoning hazard. Keep away from children.**
- Install bead cage directly into SunScents dispenser.
- **Always make certain that the dispenser cap is securely in place before operating the hot tub's air blower, to avoid the cap from flying off when the blower is activated.**

11.12 SmartTub™ System

Advances in technology have allowed us to create a better and smarter hot tub. Our SmartTub™ system operates on a cellular network. The advantages of this system are:

- A more stable connection to internet for outdoor environment. The SmartTub™ device uses much less data than a typical voice connection via cellular networks. We contract through the largest wireless carriers to ensure maximum uptime. The system enables firmware updates via the cell connection so your system's performance will continuously be optimized remotely.
- Maintenance is made easy by alerts sent to your phone.
- Diagnostic alerts are sent to you and your dealer when attention is required.

A. Pairing process

1. Download the SmartTub™ app from the Google Play store or Apple App store.
2. Open the app and create an account.
3. Locate the SmartTub™ sticker next the control panel of the hot tub. You can either scan the QR code with the SmartTub™ app or manually input the serial number located below the QR code on the sticker.
4. After you pair the hot tub's serial number to the SmartTub™ app, the app will load and connect the hot tub to the internet.
5. Follow the instructions on the app to begin enjoying the benefits of your internet connected hot tub.

Note: The first year of data service is included. You will need to renew the subscription after the first year. Please refer to the terms of service and privacy policy links in the SmartTub™ app for additional information.

B. Indicator Lights

There are indicator lights on the SmartTub™ controller that relay the status of the system. Below are meanings of the lights.

1. Cloud:
 - Blue light on - connected to cloud.
 - Blue light off - not connected to cloud.
2. Spa:
 - Blue light on - connected to spa controller
 - Blue light off - not connected to spa controller
3. Status:
 - Cyan light - breathing (slow pulsing) indicates the status is good.
 - Cyan light - flashing indicates that the system is completing a connection to the cloud.

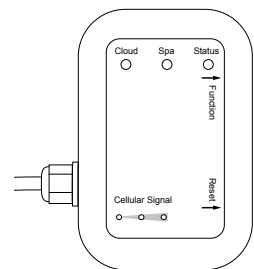

Figure 11.12a

980™ Series

- Green light - flashing indicates waiting for a connection to the cellular tower.
- Dark blue light - flashing indicates a SIM error.

4. Cell signal strength:

- 3 blue LED lights indicates cell signal strength.

C. **Resetting the SmartTub™ controller**

Should the SmartTub™ controller need to be reset, hold the magnet (located on the cord) to the reset label on the side of the SmartTub device, Figure 11.12a.

12.0 Programming and Operation Instructions







Your Sundance Spas hot tub is equipped with setting menus that allow you to program and activate different components of the spa. With our iTouch™ Glass control panel, programming your spa has never been easier. In the sections that follow, we will guide you through the process of programming the spa to fit your personal comfort. Tap  to enter the Settings Menu, Figure 12.0a and 12.0b. To view additional setting menus, swipe the screen upward.



Figure 12.0a

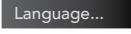
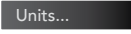
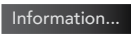

Figure 12.0b

-  = **SunCooler:** Provides access to the draining feature for the SunCooler, page 48. Menu appears on Claremont and Kingston models.
-  = **Heat and Filter:** Provides access to the heating and filtration programming, page 50.
-  = **Water Care:** Provides access to the water care programming, page 53.
-  = **SunSmart Wi-Fi:** Provides access to the SunSmart 2.0 Wi-Fi settings, page 56. Not applicable if the optional SmartTub™ system is installed.
-  = **Time and Date:** Provides access to the time and date programming, page 57.
-  = **Lock:** Provides access to activate the locking features, page 58.
-  = **Language:** Provides access to the language programming, page 59.
-  = **Units:** Allows access to the temperature display feature, either in Fahrenheit or Celsius, page 60. Default setting is Fahrenheit.
-  = **Information:** This menu will display the current information for the spa.



= **Back Button:** Tap to go back to the Home Menu.



= **Invert Button:** Tap to invert the display image.

12.1 Draining the SunCooler (Claremont and Kingston Models)

From the Settings Menu (Figure 12.1a) tap **SunCooler™...** to enter the SunCooler Drain Menu, Figure 12.1b. When water accumulates within the SunCooler bins, draining of the water can be done in one of two ways, internally into the hot tub (Figure 12.1d) or externally out of the hot tub (Figure 12.1f). There are also SunCooler perimeter drains, Figure 12.1c. When water accumulates, in the perimeter, draining is continuous any time pump 1 is running.



IMPORTANT! All measures need to be taken to completely dry and clean the SunCooler bins after each use or any time they are exposed to liquids. **Any moisture and water can potentially cause mold and mildew.** This can cause a health risk. Over time, this can damage certain surfaces, surroundings, and equipment.



Figure 12.1a



Figure 12.1b

SunCooler Components

- A. Air Control - used when draining the SunCooler bin.
- B. SunCooler Perimeter Drain - helps to drain the SunCooler perimeter from water. It drains whenever jets pump 1 is on. Also, helps to reduce water intrusion into the cooler area and preserves ice.
- C. SunCooler Bin Drain - helps to drain the SunCooler bin from water build-up.
- D. SunCooler Lid Release Handle
- E. SunCooler Lid Lock

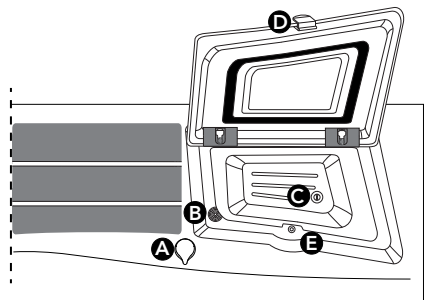

Figure 12.1c

A. SunCooler Bin Draining (Internally)

1. Tap **SunCooler** to enter the menu, Figure 12.1a.
2. Locate the drain plug inside the SunCooler, Figure 12.1d.

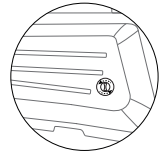

Figure 12.1d

Note: You can only drain one bin at a time.

3. Turn the thumb screw counterclockwise to remove, Figure 12.1d. Place the screw in a safe location to prevent from losing it.
4. Locate the air control that works with the bin drain, Figure 12.1c, and close it by turning it counterclockwise.



Figure 12.1e

5. Tap **Drain** to begin the draining function, Figure 12.1e. Jets pump 2 turns on to drain the water from the bin.
6. Once drained, reinstall the thumb screw and hand tighten. Then, continue to drain the other bin.

Note: Make sure to reinstall the thumb screw. If not, then air can be drawn through the Accu-Pressure jet plumbed into the draining system.



IMPORTANT! If liquids (other than water) spill into the SunCooler bins, the external draining process should be used to remove these liquids. This will prevent contaminants from entering and affecting the hot tub water.

B. SunCooler Bin Draining (Externally)

1. Turn OFF the power to the hot tub!
2. Locate the drain plug on the ABS pan of the hot tub, Figure 12.1f.
3. Turn the thumb screw counterclockwise to remove, Figure 12.1f. Place the screw in a safe location to prevent from losing it.
4. Locate the drain plug inside the SunCooler, Figure 12.1d.

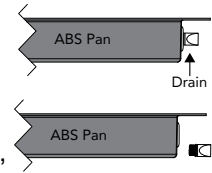

Figure 12.1f

Note: You can only drain one bin at a time.

5. Turn the thumb screw counterclockwise to remove, Figure 12.1d. Place the screw in a safe location to prevent from losing it.
6. Make sure to direct the water away from the hot tub and the equipment bay.
7. Once drained, reinstall the thumb screw and hand tighten.

C. SunCooler Lid Removal

1. Unlock and lift the lid up. At a 45° angle, the lid can be removed.

Note: Once you tilt the lid pass a 45° angle it cannot be removed.

2. Pull on the lid, slightly, to release it from the locking bolt, Figure 12.1g.
3. You need to align the locking bolt with the release slot in order to remove the lid, Figure 12.1g.

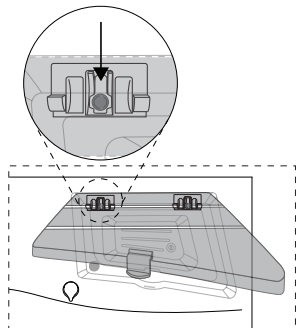

Figure 12.1g

12.2 Programming the Heating Mode

Your Sundance Spas hot tub is equipped with 3 modes of heating, Figure 12.2b. An automatic mode called “Auto” where the spa’s temperature is maintained at all times. An energy saving heating cycle called “Econ.” A mode that will only activate the heater during the daytime called “Day” mode. To view additional menus, swipe the screen upward.

Note: The heater will activate when the temperature drops 2°F (1°C) from the set temperature.

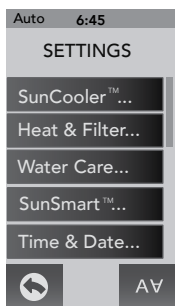

Figure 12.2a

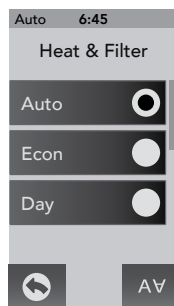

Figure 12.2b

Tap **Heat & Filter...** to enter the menu, Figure 12.2a. Then select one of the heating settings.

A. **Auto heating:**

1. When programmed to “Auto,” the spa will maintain the water temperature to the set temperature. Heating will occur when necessary.
2. To select this mode, tap the “Auto” tab.
3. This is the default setting.

B. **Economy heating:**

1. This is an energy saving heating program that allows the spa to heat during non-peak hours. When programmed to “Econ,” the spa will only be allowed to heat the water between 5:00 PM to 7:00 AM every day of the week. The hours cannot be adjusted.
2. To select this mode, tap the “Econ” tab.

C. **Day heating:**

1. When programmed to “Day,” the spa will only be allowed to heat the water between 7:00 AM to 5:00 PM every day of the week. The hours cannot be adjusted.
2. To select this mode, tap the “Day” tab.

12.3 Programming the Primary Filtration

To access the “Primary” feature, tap **Primary...** from the Heat and Filter menu, Figure 12.3a, to enter the “Primary” programming, Figure 12.3b. If the Primary tab does not appear on the LCD display, swipe the screen upward to view additional options.

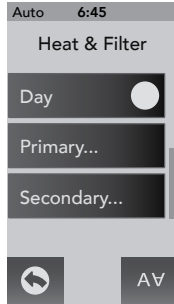

Figure 12.3a

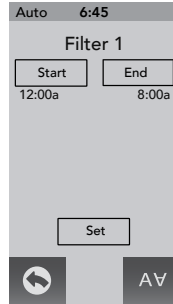

Figure 12.3b

During a primary filtration, the circulation pump, CLEARRAY and ozone unit (if applicable) are activated. The factory default cycle starts at 12:00 AM and last for 8 hours. If you elect to keep this setting, then you can skip this section.



In extreme bitter cold weather, where freezing can occur, we recommend you program the circulation pump to run 24 hours. Refer to the “Winterizing” section on page 67.

Any time the circulation pump runs outside of a program cycle, e.g. for heating, that run time will be deducted from the next primary filter cycle. For example, the primary filter cycle is set to 8 hours every 24 hours but the circulation pump comes on for 2 hours to heat the water after the cycle has finished. The next primary filter cycle will only be for 6 hours not 8 hours.

A. To change the default cycle (Figure 12.3c):

1. Tap **Start** to activate the programming settings.
2. Swipe the hour to scroll and select the start time, in 1-hour increments. To switch from “AM” to “PM” you must round a 12-Hour period.
3. Tap **Set** to accept and save the change.
4. Tap **End** to program the end time for the cycle.
5. Swipe the hour to scroll and select the end time. To switch from “AM” to “PM” you must round a 12-Hour period.
6. Tap **Set** to accept and save the change.
7. Tap **Back** to return to the Heat and Filter Menu. Tap again to return to the Settings Menu.

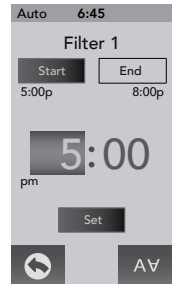

Figure 12.3c

Summer Logic: In warm weather, the water temperature in the spa may exceed the set temperature. This condition may occur due to heat transference from the filter/circulation pump and jets pumps. If the water temperature is higher than 95°F (35°C) and rises 2°F (1°C) above the set temperature, a “Summer Logic” condition occurs that deactivates the filter/circulation pump and CLEARRAY. This safety feature cannot be altered! The filter/circulation pump and CLEARRAY® will remain off until the water temperature cools to the set temperature (except when the filter/circulation pump runs for its mandatory 3-hour cycles between 8am-11am and 8pm-11pm.) To help prevent a “Summer Logic” condition, it may be necessary to reduce filter/circulation pump cycles run times in warm weather.

12.4 Programming the Secondary Filtration

To access the “Secondary” feature, tap **Secondary...** from the Heat and Filter Menu, Figure 12.4a, to enter the “Secondary” programming, Figure 12.4b.

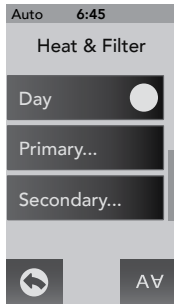

Figure 12.4a

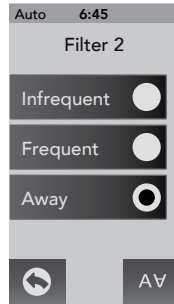

Figure 12.4b

During a secondary filtration, the Jets Pump 1 is activated. There are 3 cycles you can select from, Figure 12.4b. The factory default cycle is “Away.” If you elect to keep this setting, then you can skip this section.

A. To change the Secondary Filter cycle:

1. Infrequent Mode: Activates two cycles at 8:00 PM and 8:00 AM **every other day**. Each cycle will last 10 minutes for a total of 20 minutes every other day. To activate this mode, tap the “Infrequent” tab. Time and duration cannot be altered.
2. Frequent Mode: Activates two cycles at 8:00 PM and 8:00 AM **every day**. Each cycle will last 10 minutes for a total of 20 minutes every day. To activate this mode, tap the “Frequent” tab. Time and duration cannot be altered.
3. Away Mode: Secondary Filtration is disabled. To activate this mode, tap the “Away” tab. This is the factory default setting.
4. Tap to return to the Heat and Filter Menu. Tap again to return to the Settings Menu.

12.5 Cleanup Cycle

The cleanup cycle occurs once per day at 12:00 pm (noon). This is not user programmable. Turning off the corresponding jets pump that is running can deactivate the feature.

- Two Pump System - Jets Pump 1 and the Circulation Pump turn on for 1 minute and then shut off. Then Jets Pump 2 turns on for 1 minute and then shuts off. Then the blower turns on for 1 minute and then shuts off.
- Three Pump System - Jets Pump 1 and the Circulation Pump turn on for 1 minute and then shut off. Then Jets Pump 2 turns on for 1 minute and then shuts off. Then Jets Pump 3 turns on for 1 minute and then shuts off. Then the blower turns on for 1 minute and then shuts off.

12.6 Blow-Out Cycle

This cycle will purge the air from the plumbing lines normally caused by draining and filling the spa. The Jets Pump 1 and the Circulation Pump will turn on for 1 minute and then shut off. Then Jets Pump 2 will turn on and run for 1 minute then shut off. Lastly, Jets Pump 3 will turn on and run for 1 minute then shut off. Turning off the corresponding jets pump that is running can deactivate the feature.

12.7 Water Care Programming

Water care is crucial to maintaining a healthy and clean spa. The CLEARRAY water purification system leads the way by sanitizing the water using a UV light bulb. Your spa can be programmed to remind you when to check and replace certain components.

From the Settings Menu, tap the **Water Care...** menu tab, Figures 12.7a and 12.7b. Then select one of the features to program by tapping ◀ or ▶.



Figure 12.7a

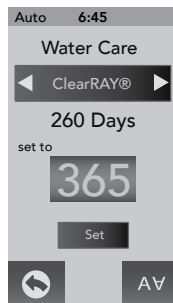

Figure 12.7b

A. Programming the CLEARRAY UV Bulb Timer



The CLEARRAY UV bulb has a life expectancy of 1 year. A timer activates when power is applied and begins a countdown starting at 365 days. Once the timer expires, an error message will appear on the display (page 76), the UV bulb must be replaced and the timer needs to be reset.

Note:

- The days are stored in memory if the power is interrupted.
- The CLEARRAY UV timer counts down by days not usage.

1. From the “Water Care” Menu you can to set the CLEARRAY UV bulb timer, Figure 12.7c.
2. Tap and scroll the days timer (365) to change the days in 10-day increments. The range is from OFF to 365 days.

Note: It is not recommended that this feature be turned OFF. In order to continually have the CLEARRAY system effectively perform its function, it should be program as instructed.

3. Tap  to confirm and save your changes.
4. Tap  to return to the Settings Menu.
5. When the timer expires, a message will appear on the control panel display, page 76. The CLEARRAY UV bulb **must be replaced** (page 70) and the timer must be reset.

Tap “reset” and follow the instructions above to reset the timer. If you tap “snooze” the message will clear but the error icon  will display and the reminder screen will reappear in 10 days.

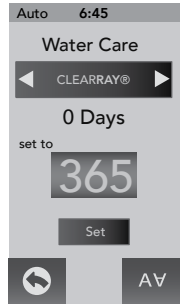





Figure 12.7c

B. Programming the Water Refresh Timer

A programmable “Water Refresh” reminder can be set to remind you when to drain and refill the spa. Tap  (Figure 12.7c) until you reach the “Water Refresh” tab to enter the Programming Menu.

1. From the “Water Care” Menu you can to set the “Water Refresh” timer, Figure 12.7d.
2. Tap and scroll the days timer 180 to change the days in 30-day increments. The range is from OFF to 180 days.

Note: It is not recommended that this feature be turned OFF. In order to continually maintain the water healthy and clean, in addition to chemical maintenance, it should be program as instructed.

3. Tap  to confirm and save your changes.
4. Tap  to return to the Settings Menu.
5. When the timer expires, a message will appear on the control panel display, page 77. The water must be drained and replaced with fresh water. Follow the instructions above to reset the timer. If you tap “snooze” the message will clear but the error icon  will display and the reminder screen will reappear in 10 days. Refer to Section 13.3, page 64, for filter location.

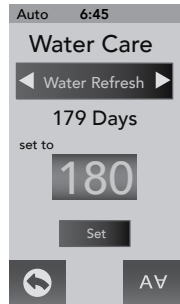

Figure 12.7d

C. Programming the MicroClean Outer Filter Timer

A programmable filter timer can be set to remind you when to clean or replace the MicroClean Outer Filter. Tap ► (Figure 12.7d) until you reach the “MicroClean Outer” tab to enter the Programming Menu (Figure 12.7e).

1. From the “Water Care” Menu you can to set the MicroClean Outer timer, Figure 12.7e.
2. Tap and scroll the days timer **180** to change the days in 10-day increments. The range is from OFF to 180 days.

Note: It is not recommended that this feature be turned OFF. In order to continually maintain clean and working filters, it should be program as instructed.

3. Tap **Set** to confirm and save your changes.
4. Tap **◀** to return to the Settings Menu.
5. When the timer expires, a message will appear on the control panel display, page 76. The filter must be cleaned or replaced. Follow the instructions above to reset the timer. If you tap “snooze” the message will clear but the error icon ▲ will display and the reminder screen will reappear in 10 days. Refer to Section 13.1, page 61, for cleaning instructions.

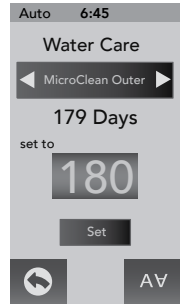

Figure 12.7e

D. Programming the MicroClean Inner Filter Timer

A programmable filter timer can be set to remind you when to replace the MicroClean Inner Filter. Tap ► (Figure 12.7e) until you reach the “MicroClean Inner” tab to enter the Programming Menu, Figure 12.7f.

1. From the “Water Care” Menu you can to set the MicroClean Inner timer, Figure 12.7f.
2. Tap and scroll the days timer **90** to change the days in 10-day increments. The range is from OFF to 90 days.

Note: It is not recommended that this feature be turned OFF. In order to replace the filter when required it should be program as instructed.

3. Tap **Set** to confirm and save your changes.
4. Tap **◀** to return to the Settings Menu.
5. When the timer expires, a message will appear on the control panel display, page 77. Follow the previous instructions to reset the timer. The filter must be replaced. Refer to Section 13.1, page 61, for filter location. If you tap “snooze” the message will clear but the error icon ▲ will display and the reminder screen will reappear in 10 days.

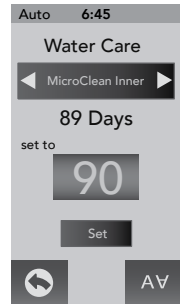

Figure 12.7f

12.8 SunSmart 2.0 Wi-Fi Setup (not applicable if the optional SmartTub™ system is installed)

From the Settings Menu, tap **SunSmart™ ...** to enter the programming options, Figures 12.8a and 12.8b. Make sure that you have downloaded the Wi-Fi App for this setup.

Note: A blinking Wi-Fi icon indicates that there is a communication issue between the hot tub and router.

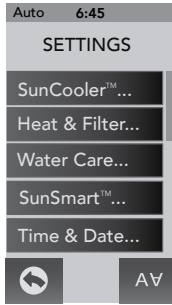

Figure 12.8a

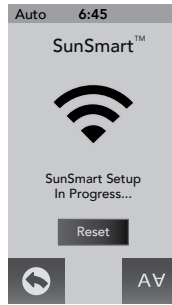

Figure 12.8b

1. You need to follow the instructions from the App in order to connect the Wi-Fi.
2. While the system attempts to connect you will see the, “SunSmart Setup In Progress,” Figure 12.8b. When the connection is done the display will read, “SunSmart Setup Successfully Connected.”

If the Wi-Fi connection setting should need to be updated or connected to a new router, follow the steps below.

1. From the “Settings” menu, tap **SunSmart™ ...** (Figure 12.8a) to enter the menu.
2. Tap **Reset**, Figure 12.8c. The display will change to “Spa Wi-Fi Setup In-progress.”
3. Tap **Reset** again. This will clear the current data and allow the spa to connect to the new data.
4. Reconfigure and setup your spa by following the instructions from the app.



Figure 12.8c

12.9 Programming the Time and Date

From the Settings Menu, tap **Time & Date...** to enter the programming options, Figure 12.9b.

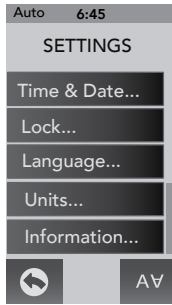

Figure 12.9a

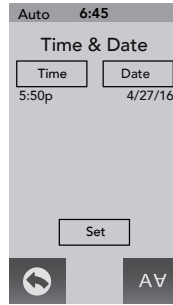

Figure 12.9b

A. To set the time:

1. When you enter the menu, tap **Time** to start to program the time, Figure 12.9b.
2. Tap and scroll the hour block **5:50** to program and change the hour in 1-hour increments, Figure 12.9c. To switch from “AM” to “PM” you must round a 12-Hour period.

The default time setting is a 12-Hour configuration. To choose the 24-Hour configuration, then tap **12/24** to change the setting.

3. Tap and scroll the minutes block **5:50** to program and change the minutes.
4. Tap **Set** to confirm and save your changes.

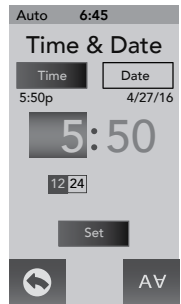

Figure 12.9c

B. To set the date:

Each setting for month, day, and year are set independently.

1. Tap **Date** to program the date, Figure 12.9d.
2. Tap and scroll the month block **4** to program.
2. Tap and scroll the day block **27** to program.
3. Tap and scroll the year block **2016** to program.
4. Tap **Set** to save and accept the changes.
5. Tap **Back** to return to the “Settings” Menu.

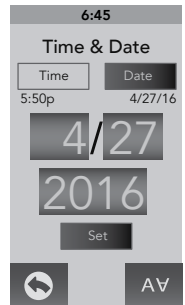



Figure 12.9d

12.10 Locking the Spa

From the Settings Menu, tap **Lock...** to enter the programming options, Figure 12.10b. You can prevent users from changing certain features of the spa. When a lock feature is active, the lock icon  will appear on the Main Menu.

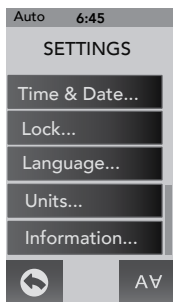

Figure 12.10a

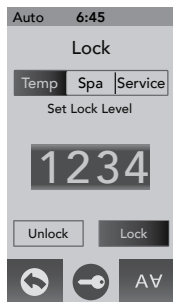



Figure 12.10b

A. Temp Lock (Figure 12.10b):

1. Tap **Temp** to lock the temperature feature.
2. Tap and scroll **1000** (the first number) to select a number from 0-9. Then move on to the next number until a four-digit code has been selected.
3. Tap **Lock** to activate the locking feature.
4. The adjust temperature feature is disabled, but the spa will still perform all scheduled tasks.
5. Tap  to return to the “Settings” Menu.

B. Spa Lock (Figure 12.10b):

1. Tap **Spa** to lock the spa. When this feature is activated both the spa and temperature are locked.
2. Tap and scroll **1000** (the first number) to select a number from 0-9. Then move on to the next number until a four-digit code has been selected.
3. Tap **Lock** to activate the locking feature.
4. All activation and adjustment features are disabled but the spa will still perform all scheduled tasks.
5. Tap  to return to the “Settings” Menu.

C. Service Lock (Figure 12.10b):



1. Tap **Service** to lock the spa. When this feature is activated all the spa functions are locked.
2. Tap and scroll **1000** (the first number) to select a number from 0-9. Then move on to the next number until a four-digit code has been selected.
3. Tap **Lock** to activate the locking feature.

- All spa functions are locked to allow for a temporary service mode such as filter cleaning.

Note: This mode has a time out of 2 hours. The spa should not be left in this lock mode for an extended period. Especially in colder climate or when freezing conditions exist. Also, when the spa exists this locking mode, a blow out cycle will occur, page 53.

- Tap  to return to the “Settings” Menu.

D. To Unlock (Figure 12.10c):

- Enter the Lock menu. The type of lock that is active will already be highlighted.
- Tap and scroll **1000** (the first number) to select a number from 0-9. Then move on to the next number until a four-digit code has been selected.
- Tap  to deactivate the locking feature.
- Tap  to return to the “Setting” Menu.

Note: A default passcode can be used in case the original passcode is lost or forgotten. The code “0772” will unlock the locked setting.

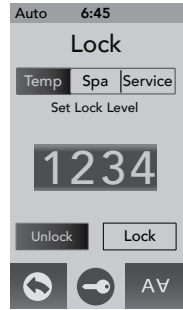
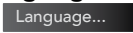

Figure 12.10c

12.11 Programming the Language

From the Settings Menu, tap  to enter the programming options, Figure 12.11b.

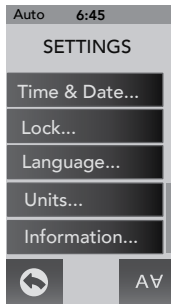



Figure 12.11a



Figure 12.11b

- There are 4 languages to select from: English, Spanish, French, and German. To select a language, tap the language tab you want to display, Figure 12.11b.
- Tap  to return to the “Settings” Menu.

12.12 Units Display

From the Settings Menu, tap **Units...** to enter the programming options, Figure 12.12b.

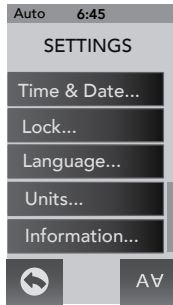

Figure 12.12a

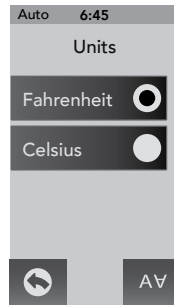



Figure 12.12b

1. Tap the unit of measure that you want to display.
2. Tap  to return to the “Settings” Menu.

12.13 System Information

This menu will display the current information for the spa. From the Settings Menu, tap **Information...** to enter the menu, Figures 12.13a and 12.13b. There are no selections that can be made. The menu simply provides information.

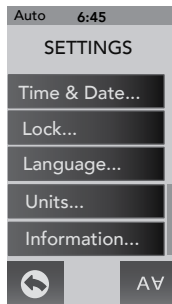

Figure 12.13a

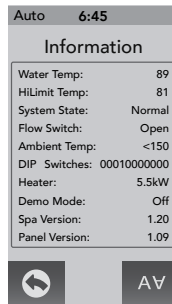

Figure 12.13b

13.0 Hot Tub Maintenance

Proper and regular maintenance of your hot tub will help it retain its beauty and performance. Your authorized Sundance Spas dealer can supply you with all the information, supplies, and accessory products you will need to accomplish this.



DANGER: RISK OF SEVERE INJURY OR DROWNING BY ENTRAPMENT!

- Keep hair, loose articles of clothing or hanging jewelry away from suction fittings, rotating jets or other moving components to avoid entrapment that could lead to drowning or severe injury.
- Never use the spa unless all suction guards, filter, filter lid, or skimmer assembly are installed to prevent body and/or hair entrapment.
- Never operate or use the spa if the filter, filter lid, or skimmer assembly are broken or any part of the skimmer assembly is missing. Please contact your dealer or nearest service center for service.
- The suction fittings and suction covers in this spa are sized to match the specific water flow created by the pump(s). If it is necessary to replace the suction fittings, suction covers or pump(s), be sure that the flow rates are compatible and are in compliance with the VGB Safety Act, page 2.
- Never replace a suction fitting or suction cover with one rated less than the flow rate marked on the original suction fitting. Using improper suction fittings or suction covers can create a body or hair suction entrapment hazard that may lead to drowning or severe injury.
- Owners must alert all spa users to the potential risk of Hair, Limb, Body, Evisceration (disembowelment), and Mechanical Entrapment, page 7.

13.1 Cleaning/Replacing the Filter Cartridge

A reminder message appears on the control panel display, after a specified number of days, to remind you to clean the MicroClean Ultra filters. This reminder must be reset at each interval. Refer to Section 12.7, for additional information and programming details.

Your Sundance hot tub is equipped with a two-stage MicroClean Ultra filter cartridge assembly under the filter lid (Sections 9.1-9.12 pages 21-32). Debris is filtered by the filter/circulation pump drawing water through the filter assembly 8 hours a day, 7 days a week (unless programmed otherwise). To ensure optimum performance, clean the outer pleated filter and center insert monthly. Then replace the center insert every 6 months, or as needed thereafter.

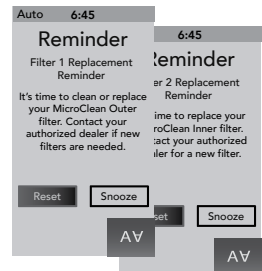

980™ Series

All models include a suction cover filter (#6540-213) located directly under the MicroClean Ultra filter cartridge assembly that prevents debris from entering the hot tub plumbing when jets pump 1 is running. This filter should be cleaned every 2 months.

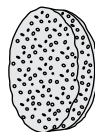

TO DECREASE RISK OF DEATH, DROWNING, OR ENTRAPMENT, ALWAYS TURN POWER TO THE HOT TUB OFF BEFORE REMOVING THE MicroClean ULTRA FILTER ASSEMBLY!

Filter Cleaning/Replacement Procedure:

1



DANGER: TURN POWER TO SPA OFF! TO DECREASE RISK OF DEATH, DROWNING, OR ENTRAPMENT, NEVER OPERATE SPA WHEN FILTER IS NOT PROPERLY INSTALLED OR IF WEIR ASSEMBLY IS DAMAGED OR ALTERED!



2

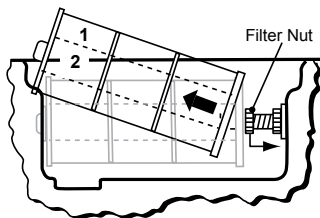

Filter Cleaning Requirements:

- Clean MicroClean Ultra Pleated Filter (1) monthly and replace every 18 months (6473-165).
- Rinse off MicroClean Ultra Insert (2) monthly and replace every 6 months or as needed (6473-164).

Filter Removal Instructions:

Loosen filter nut to provide clearance, then remove MicroClean Ultra Filter Assembly from spa.

3

Monthly Filter Cleaning Procedure

We recommend cleaning the outer pleated filter (1) with a high pressure water nozzle and the filter insert (2) with a low-pressure water nozzle monthly. Periodically, the outer pleated filter cartridge (1) will require a more thorough cleaning to remove embedded oils and minerals by using special spa filter cleaners offered by your spa dealer. Always remove the center filter insert (2) before cleaning the outer filter (1) with chemicals. Never use filter cleaners of any kind on the filter insert (2) or it may be damaged, come apart or allow impurities to re-enter the water, increasing the risk of contracting a waterborne illness (e.g. an infection, bacteria or virus) and/or respiratory ailments.

Procedure:

1. Grasp center filter insert end cap (2) in hand and pull outward from pleated cartridge (1). If filter insert (2) is 6 months old, throw it away and purchase new one. DO NOT install new insert at this time.
2. Rinse debris from all outer filter (1) pleats using a garden hose and high-pressure nozzle. Repeat process until all filter pleats are clean. Then rinse debris from inside of filter (1). If chemical cleaners are used, follow manufacturers instructions.

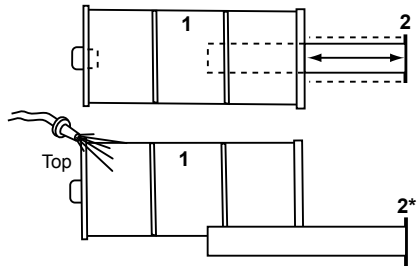

Lightly rise filter insert (2) and place in clean location. *DO

NOT use chemical cleaners or high-pressure nozzle on insert (2) or it may be damaged, come apart or allow impurities to re-enter the water, increasing the risk of contracting a waterborne illness (e.g. an infection bacteria or virus) and/or respiratory ailments.

3. Install filter insert (2) into outer pleated filter (1) by gently sliding inward until a slight resistance is felt approximately 1/4" from bottom. Lightly tap insert end with palm of hand to "snap" in place. Insert is properly installed when end cap rests "flush" against outer filter end cap.
4. Install Filter assembly back into spa by performing step 2 in reverse order. Tighten filter nut so it just touches the filter face. DO NOT OVERTIGHTEN!
5. Turn power to spa back on.

Replacement filter cartridges may be purchased from your Sundance Spas dealer.

13.2 Removing the cabinet panels

The quick removal of the cabinet panels provide easy access to the equipment bay and components without having to unscrew the panel. To remove the panels follow the steps below:

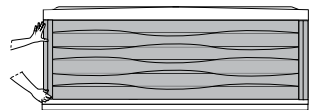

Figure 13.2a

1. Grab one of the corner panels, from the bottom, and gently pull the cabinet forward to unsnap it from the holding clip. Then slide it down to remove. Place the panel in a safe location to prevent from damaging it. Repeat the steps to remove the other corner panel, Figure 13.2a.

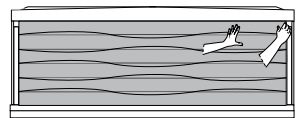

Figure 13.2b

2. Remove the center panel. Grab either the top left or top right side of the front center panel, Figure 13.2b. Gently pull the cabinet forward to unsnap it from the holding clips. Make sure to support the cabinet as you work your way down the side to completely unclip it from the hot tub frame. Once completely unclipped, tilt slightly forward and lift up to remove it from the hot tub frame. Place the panel in a safe location to prevent from damaging it.
3. This will expose the equipment bay for easy access to components like the CLEARRAY System and the Quick Drain Valve. Place the panel in a safe location to prevent from damaging it.
4. To reinstall the panel just follow the steps above in reverse order.

13.3 Draining And Refilling

Every 3 months, you will need to replace the hot tub's water. The frequency depends on a number of variables including the amount of use, attention paid to water quality maintenance, etc. You will know it is time for a change when you cannot control sudsing and/or you can no longer get the normal feel or sparkle to the water even though the key water balance measurements are all within the proper parameters.



CAUTION! READ THIS BEFORE DRAINING: To decrease damage to the hot tub's components, turn off power to the hot tub at the circuit breaker before draining it. Do not turn the power back on until your hot tub has been refilled. There are certain precautions to keep in mind when draining your hot tub. If it is extremely cold, and the hot tub is outdoors, freezing could occur in the lines or the equipment (see "Winterizing," page 67). On the other hand, if it is hot outdoors, do not leave the hot tub's surface exposed to direct sunlight for long periods.

Draining Procedures:

1. Turn off power to hot tub at the breaker.
2. Grab one of the corner panels, from the bottom, and gently pull the cabinet forward to unsnap it from the holding clip. Then slide it down to remove. Place the panel in a safe location to prevent from damaging it. Repeat the steps to remove the other corner panel, Figure 13.3a.
3. Remove the center panel. Grab either the top left or top right side of the front center panel, Figure 13.3b. Gently pull the cabinet forward to unsnap it from the holding clips. Make sure to support the cabinet as you work your way down the side to completely unclip it from the hot tub frame. Once completely unclipped, tilt slightly forward and lift up to remove it from the hot tub frame. Place the panel in a safe location to prevent from damaging it.

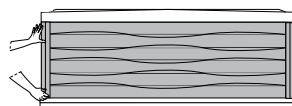

Figure 13.3a

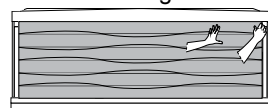

Figure 13.3b

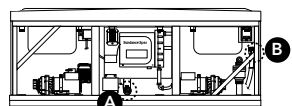

Figure 13.3c

4. Locate one of the two drains that you would like to use, Figure 13.3c. Either the Quick Drain (A) or the 3/4" drain valve (B). Once you choose a draining method, follow the procedures for that method.

A. Draining procedures for the Quick Drain™:

1. Turn off power to hot tub at breaker.
2. Locate the Quick Drain Valve, Figure 13.3d.
3. Unscrew drain valve cap (Figure 13.3e). Place the cap aside.
4. Screw in the adapter with hose that was included in the equipment bay. Attach it to the quick drain (Figure 13.3e). Make sure to direct the hose to an area where the water will drain properly.
5. Open the drain slice valve by sliding the handle to the side and pulling up.
6. After the hot tub has drained close the slice valve by pushing it downward and sliding the handle to the side. Remove the adapter and reinstall the Quick drain cap before refilling hot tub.

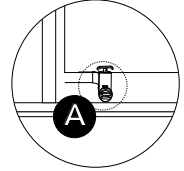

Figure 13.3d

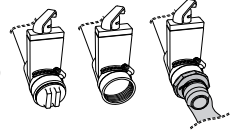

Figure 13.3e

Note: Refer to “Hot Tub Fill Up Procedure” (page 17) for recommended filling instructions.

B. Draining Procedures for the Drain Valve:

1. Turn off power to hot tub at breaker.
2. Locate drain hose line attached to the 2 x 4 wood slat, Figure 13.3f. Hold drain hose above water line. Unscrew drain valve cap to expose the underlying male garden hose fitting, Figure 13.3g.
3. Attach female garden hose end to drain fitting and route opposite end of garden hose away from hot tub, Figure 13.3g. **Note:** Make sure to direct water away from hot tub.
4. After spa has completely drained, reinstall drain cap on drain valve finger tight! **DO NOT OVERTIGHTEN!**
5. Place drain hose back inside the spa equipment bay.



Figure 13.3f

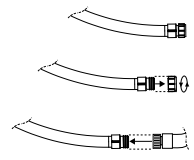

Figure 13.3g

Note: Refer to “Hot Tub Fill Up Procedure” (page 17) for recommended filling instructions.

13.4 Cleaning The Hot Tub Interior

To preserve the sheen of your hot tub's surface, it is crucial that you avoid using abrasive cleaners or cleaners which have adverse chemical effect on the surface. If you are not certain as to the suitability of a particular cleanser, consult your authorized Sundance Spas dealer. Regardless of the cleanser used, use extreme care to assure that no soap residue is left on the surface. This could cause severe sudsing when the hot tub is refilled.

13.5 Pillow Care

Remove and clean the headrest pillows as needed with soapy water using a cloth or soft-bristle brush. Always remove the pillows when adding chemical shock treatment to the spa water. The pillows can be returned to the spa when the sanitizer reading is stable as recommended on the inside cover of the manual.



1. Place both hands on the pillow as shown, Figure 13.5a.
2. Press inward to curl pillow so you can grab it with fingertips, Figure 13.5b.
3. Gently pull upward on pillow to release the mounting stud from receptacle on spa shell, Figure 13.5c.
4. Wash pillow(s) in a mild detergent soap and warm water solution. Never machine wash your pillows or attempt to clean them with a cleaning agent.
5. To reinstall pillows simply align pillow over the mounting stub receptacle then gently push downward to snap in place.



Figure 13.5a



Figure 13.5b



Figure 13.5c

13.6 Maintaining the Hot Tub Cabinet

The hot tub cabinet requires little or no maintenance of any kind. To clean, wipe cabinet with a clean towel and mild detergent soap solution.



CAUTION: Never spray cabinet with a high pressure garden hose for any reason since this action may induce an electrical short in the hot tub's electrical equipment.

13.7 Cover Care And Maintenance

Certain hot tub covers distributed by Sundance Spas, Inc., have a vinyl or SUNSTRONG™/SUNSTRONG™ Extreme encasement. This vinyl or SUNSTRONG/SUNSTRONG Extreme encasement also referred to as the cover “skin” is attractive and durable. Regular monthly cleaning and conditioning (vinyl) is strongly recommended and may increase the longevity of your cover.

A. To clean and condition the encasement (cover skin):

1. Use a garden hose to remove any debris.
2. Using a large sponge or soft bristle brush, use diluted or mild soap to gently scrub the top.
3. Rinse and clean and do not allow soap to dry on the cover. Do not use soap on the underside of the cover.
4. Please check with your Sundance Spas dealer for recommended cover care and conditioning products. Use non-petroleum based conditioners to keep the vinyl supple.
5. Do not use any solvents, abrasive cleaners or strong detergents. Do not use products that contain silicone or alcohol.

B. Additional Care and Maintenance Instructions:

1. Debris can accumulate on the spa cover. Removal of snow or other debris will help to avoid breakage of the foam cores.
2. Be sure to lock the cover straps to secure the cover from unwanted or accidental entry.
3. Do not place heavy objects on the vinyl.
4. Do not walk, sit or stand on the cover.
5. Do not drag or use the flaps/skirt or the cover lock straps to remove the cover.
6. Use only recommended cover lift systems.
7. Use only chemicals and cleaners recommended by Sundance Spas.
8. Remember to keep spa covered when not in use. Maintaining proper water levels assures efficient operation and efficient electrical usage.
9. Do not expose your spa to the sun for extended periods of time as UV rays can damage the interior surface.
10. Use caution when removing cover. Before removing cover, assure all locks have been released to avoid lock breakage and/or cover strap damage.

13.8 Winterizing

Your Sundance hot tub is designed to automatically protect itself against freezing when operating properly. During periods of severe freezing temperatures, you should check periodically to be certain that the electrical supply to the hot tub has not been interrupted. In extreme bitter cold weather, less than 32°F (0°C), program the circulation pump to run for 24 hours to prevent freezing.

If you do not intend to use your hot tub, or if there is a prolonged power outage during periods of severe freezing temperatures, **it is important that all water be removed from the hot tub and equipment to protect against damage from freezing.**

Expert winterization of your spa is highly recommended, contact your authorized Sundance Spas dealer. In emergency situations, damage can be minimized by taking the following steps:

CAUTION: TURN OFF POWER TO HOT TUB!

1. Follow the directions (Section 13.3) for draining the hot tub.
2. Turn the massage/diverter selector(s) to the middle combo position to allow the water in the plumbing lines to drain, page 43.
3. Turn the waterfall valve(s) to the open position to allow the water in the plumbing lines to drain, page 43.
4. As the water level drops below the seats, use whatever means necessary to get the water out of the recessed seating areas and into the footwell, such as a wet/dry vacuum.
5. Open all the air controls and leave them open until you resume use of the spa, page 44.
6. When the water level ceases to drop, use whatever means available to remove any remaining water from the footwell, such as a wet/dry vacuum.

7. Remove the equipment-side cabinet panels and locate the drain plugs in the front of each pump (Figures A and B, page 14). Remove these plugs to allow the water to drain out of the pumps and heater.
Note: Approximately 1 to 2 gallons will be released during this procedure. Use a wet/dry vacuum or other means to keep this from flooding the equipment compartment. Replace the drain plugs.
8. Loosen hose clamp at bottom of heater (Figures A and B, page 14) and pull hose off of heater fitting (twist the hose back and forth while pulling downward). Tip hose down and allow to drain, then reinstall hose and clamp.
9. Loosen hose clamp at bottom of CLEARRAY system and pull hose off of CLEARRAY fitting (twist the hose back and forth while pulling downward). Tip hose down and allow to drain, then reinstall hose and clamp. Remove the cover of the CLEARRAY system to access the UV bulb and quartz tube. Remove and store the UV bulb in a safe location. Remove and dry off the quartz tube then reinstall it. Depending on the length of time, consider replacing the UV bulb when you resume use of your hot tub.
10. Re-install cabinet side panels and cover hot tub so that no moisture can enter into it. Consult your Sundance Spas dealer if you have any questions regarding winter use or winterizing.

13.9 Restarting Your Hot Tub in Cold Weather

If you want to start up your hot tub after it has sat empty for a time in freezing temperatures, be aware that the water remaining in certain sections of the piping may still be frozen. This situation will block water flow preventing the hot tub from operating properly and possibly damaging the equipment. We recommend you consult your dealer for guidance before attempting to restart your hot tub under these conditions.

13.10 Synthetic Inserts

The decorative synthetic inserts can be removed by gently lifting the panels and unsnapping the receptacle from the socket on the spa shell, Figure 13.10a. To reinstall, align the receptacle with the socket and gently press to snap the pieces back together. It is recommended that any water trapped between the spa shell and the synthetic inserts be removed and dried.

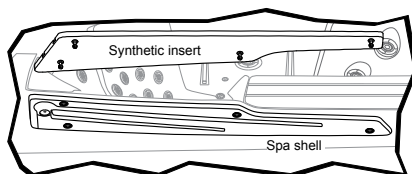

Figure 13.10a
(Actual product may vary from one shown)

14.0 Water Quality Maintenance

To decrease the risk of contracting a waterborne illness (e.g. an infection, bacteria or virus) and/or respiratory ailments, maintain water quality within specified limits. This will enhance your enjoyment and prolong the life of the hot tub's equipment. Doing so requires regular attention because the water chemistry involved is a balance of several factors. Procrastination in regard to water maintenance will result in poor and potentially unhealthy conditions for soaking and even damage to your hot tub investment. For specific guidance on maintaining water quality, consult your Authorized Sundance Spas dealer who can recommend appropriate chemical products for sanitizing and maintaining your hot tub.



WARNING: FAILURE TO MAINTAIN WATER QUALITY WILL:

- Increase risk of contracting a waterborne illness (e.g. an infection bacteria or virus) and/or respiratory ailments.
- Damage the equipment, components and spa shell, which are not covered under the hot tub's warranty.

CAUTION: Never store hot tub chemicals inside the hot tub's equipment bay. The equipment bay may reach elevated temperatures, this is where high voltage electronic devices are located. This area is not intended for storage of any kind.

14.1 pH Control

pH is a measure of relative acidity or alkalinity of water and is measured on a scale of 0 to 14. The midpoint of 7 is said to be neutral, above which is alkaline and below which is acidic. In hot tub water, it is very important to maintain a slightly alkaline condition of 7.4 to 7.6 pH. Problems become proportionately severe the further outside of this range the water gets. A low pH will be corrosive to metals in the hot tub equipment. A high pH will cause minerals to deposit on the interior surface (scaling). In addition, the ability of the sanitation agents to keep the hot tub clean is severely affected as the pH moves beyond the ideal range. That is why almost all hot tub water test kits contain a measure for pH as well as sanitizer.

14.2 Sanitizing

To destroy bacteria and organic compounds in the hot tub water, a sanitizer must be used regularly. Your Sundance hot tub is equipped with the Brominator™, a special compartment built into the floating skimmer gate to hold the SunPurity™ mineral cartridge designed specifically for your hot tub or bromine tablets. By regulating the number of bromine tablets in the Brominator you can control the amount of bromine, which is actively working, in your hot tub water. A bromine residual of no less than 2.0 ppm is generally considered desirable. A two-part bromine system or granular chlorine (dichlor) are also acceptable sanitizers. When adding spa shock (chlorine or non-chlorine) or pH balancing chemicals, activate the jets pump(s) and leave the spa cover open for a minimum of 20 minutes. By doing this you will allow excess chemical vapors to exit the spa, protecting pillows and plastic knobs from chemical attack.



WARNING: RISK OF PERSONAL INJURY, DROWNING OR ENTRAPMENT!

Never leave your hot tub unattended for any reason while the cover is open and accessible, especially to small children and animals!

CAUTION: RISK OF PERSONAL INJURY OR SPA DAMAGE!

Never add chlorine tablets (trichlor) or acid to your hot tub for any reason! These chemical may damage components within your hot tub, burn or irritate your skin, create a rash, and void the manufacturer warranty for your spa.

14.3 CLEARRAY Water Purification System

Your new hot tub has our water purification system factory installed that will begin disinfecting your water instantly. CLEARRAY Water Purification System is exclusive technology utilizing natural ultraviolet technology to sanitize your water, disinfecting bacteria, viruses, and algae in portable hot tubs. The ultraviolet light otherwise known as UV-C or germicidal light inactivates the microorganisms by disrupting the DNA so that it cannot reproduce and is considered lifeless. The ballast is the power supply for the purification system; it has two LED indicator lights the green indicating incoming power flow and the red indicating the system is properly working. CLEARRAY is standard for all models.

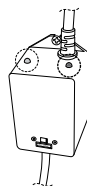
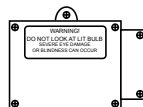

After a year the bulb must be replaced. A message will appear on the LCD display when the time allotted has expired. In order to clear the message, a new UV bulb needs to be installed and the timer must be reset (page 53).



WARNINGS:

- Do not operate the UV-C emitter when it is removed from the appliance enclosure.
- This appliance contains a UV-C emitter.
- Unintended use of the appliance or damage to the housing may result in the escape of dangerous UV-C radiation. UV-C radiation may, even in little doses, cause harm to the eyes and skin.
- Appliances that are obviously damaged must not be operated.
- Read the maintenance instructions before opening the appliance.

14.4 CLEARRAY Bulb Replacement and Quartz Tube Maintenance

Important: It is **MANDATORY** that the UV bulb is replaced and the quartz tube be cleaned every 12 months to maintain optimum performance.

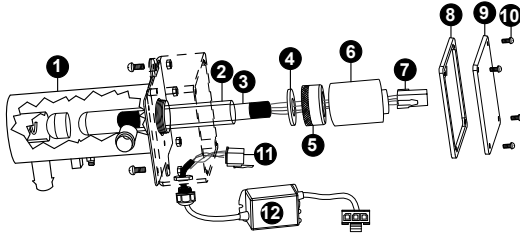

FIGURE 1



DANGER: TURN THE SPA BREAKER TO THE OFF POSITION!



DANGER: DRAIN THE SPA IF YOU ARE REPLACING OR CLEANING THE QUARTZ TUBE!



WARNING: ALLOW LAMP TO COOL DOWN PRIOR TO REMOVING FROM QUARTZ TUBE.



DANGER: NEVER LOOK AT THE LIT BULB. THIS CAN CAUSE SEVERE EYE DAMAGE OR BLINDNESS.

UV bulb replacement and quartz tube maintenance:

Note: Location of CLEARRAY System and connection may vary by model.

1. Turn the breaker to the spa OFF. DRAIN YOUR SPA.

Note: If you are only replacing the UV bulb then the spa does not have to be drained. You will need to drain it if you are replacing or cleaning the quartz tube.

2. Once the UV bulb has cooled off remove the CLEARRAY System enclosure cover (9) and gasket (8) by removing the four screws (10). This will expose the UV bulb and connections, Figure 2.

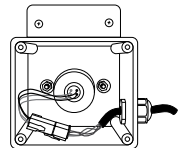

FIGURE 2



DANGER: NEVER REMOVE COVER WITHOUT FIRST TURNING OFF AT POWER SOURCE AND DRAINING THE SPA.

FIGURE 3

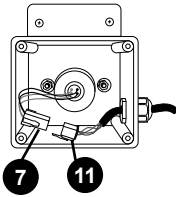

FIGURE 4

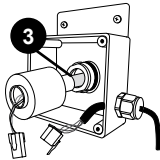

FIGURE 5

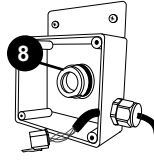
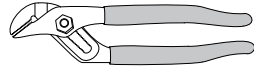

FIGURE 6



3. Disconnect UV bulb socket (7) from the power cord socket (11), Figure 3.
4. Slowly remove the UV bulb (3) out of the quartz tube, Figure 4.
5. Remove the quartz seal compression nut (5) by turning it **counterclockwise**, Figure 5. Use a pair of channel-lock pliers if needed, Figure 6. You will notice that there is a stainless steel compression washer (4) which slides over the quartz tube, save the washer (4) for later use, Figure 7.

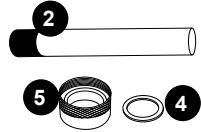

FIGURE 7

6. Now you are ready to clean or replace the quartz tube (2). For cleaning the quartz tube (2), follow steps 7 and 8 then proceed from step 9. For replacing quartz tube (2), skip steps 7 and 8 and proceed from step 9.
7. **Cleaning quartz tube:** Clean the quartz tube by wiping, until clear, using a paper towel or a dry cotton cloth. If needed, a household tub and shower lime removal product can be used.



WARNING: Do not use abrasive cleaners as they can scratch the quartz tube surface.

8. Rinse the quartz tube with clean water to completely remove any cleaning products that were used in step 7.
9. **Replacing quartz tube:** You will notice that the new quartz tube does not have a black cushion on the domed end as the old quartz tube does. This is normal as the cushion was provided with the original quartz tube to protect it from breakage during transportation. Place the new quartz tube (2) into the water chamber (1) with the domed end first making sure it is inserted and seated inside the quartz end holder. Only a small portion will be exposed when it is seated correctly.
10. Reinstall the compression washer (4) over the open end of the quartz tube (2).
11. Reinstall and hand tighten the quartz seal compression nut (5) by turning it **clockwise**.
12. Refill your spa.
13. **System Test 1:** Assure there is no water dripping from the seal compression nut (5). If water is visible, STOP and tighten the compression nut (5) using a pair of channel lock pliers to a maximum of 1/4 turn. If that does not fix the leak, then repeat quartz tube maintenance process from step 1 through step 12. Make sure there is no water leaking before proceeding to step 14.

14. **System Test 2:** Reconnect the CLEARRAY unit to the controller. Turn breaker back ON. Turn on the pump to circulate the water through the CLEARRAY System. Wait for 5 minutes and assure no water is dripping. If water is visible, STOP, fix the leak by repeating quartz tube maintenance process from step 1 through step 13. **Make sure there is no water visible. Turn the pump and breaker OFF BEFORE proceeding to step 15.**
15. Reconnect the UV bulb socket (7) to the power cord socket (11) make sure you use the latex glove provided when handling the UV bulb.



WARNING: DO NOT TOUCH THE NEW UV BULB WITH YOUR BARE HAND. Oil on your skin will cause hot spot on the UV bulb and shorten the life of your UV bulb. Use the provided latex glove to handle the UV bulb.

16. Slide the new UV bulb (3) back inside the quartz tube.
 17. Reinstall the black bulb boot (6) back over the quartz seal compression nut (5).
 18. Reinstall the enclosure cover (9) with gasket (8) and secure with the screws.
 19. Properly dispose of the old UV bulb.



WARNING: This CLEARRAY System includes a UV bulb, which contains mercury. Dispose of the bulb in accordance with disposal laws. See www.lamprecycle.org.

20. Once power is activated you can check the ballast (12), Figure 8, to see if the CLEARRAY System is functioning; it has two LED indicator lights the green indicating incoming power flow and the red indicating the system is properly working.

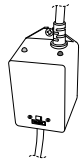



FIGURE 8

14.5 Other Additives



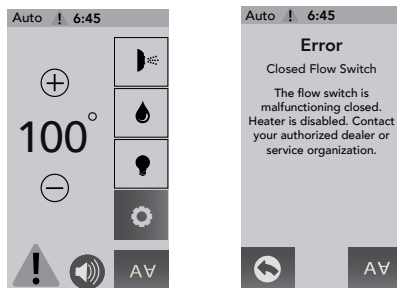

Many other additives are available for your hot tub. Some are necessary to compensate for out-of-balance water, some aid in cosmetic water treatment and others simply alter the feel or smell of the water. Your Authorized Sundance Spas dealer can advise you on the use of these additives.

15.0 Troubleshooting - Display Messages

There are a number of unique functions designed into your Sundance hot tub to protect it from damage and/or to aid in troubleshooting. The error indicator  as well as a screen will notify you when the spa needs immediate attention. Following is a listing of all the possible messages along with their meanings. **Always insist on genuine Sundance replacement parts.**





1. Open Flow Switch: The flow switch is open. Heater is disabled. The circ pump's filter is dirty, or an air lock has occurred at the pump intake. Refer to owner's manual for additional information. Clean the filters.
 2. Closed Flow Switch: (Heater is deactivated. The filter/circulation may also be deactivated.) The flow switch is malfunctioning closed. Contact your authorized dealer or service organization.
 3. Flow Restriction: Heater is disabled, check for dirty filter. Consult the owner's manual for additional information.
- Note:** Make sure to clean the filter(s) and correct proper water level before contacting your dealer or service organization.
4. Shorted Hi-limit Temp Sensor: The hi-limit temperature sensor is not functional. Heater is disabled. This must be repaired only by a qualified authorized service organization or service technician.
 5. Open Hi-limit Temp Sensor: The hi-limit temperature sensor is not functional. Heater is disabled. This must be repaired only by a qualified authorized service organization or service technician.
 6. Shorted Water Temp Sensor: The temperature sensor is not functional. Heater is disabled. This must be repaired only by a qualified authorized service organization or service technician.
 7. Open Water Temp Sensor: The temperature sensor is not functional. Heater is disabled. This must be repaired only by a qualified authorized service organization or service technician.
 8. Closed Flow Switch on Start-up: Flow switch is non-functional. Closed or shorted flow switch on system start-up (system disabled). Contact your authorized dealer or service organization.

9. **Frozen on Start-up:** Flow switch is non-functional. Shorted flow switch on system start-up (system disabled) and freeze condition detected. Contact your authorized dealer or service organization.
10. **Cool Warning:** Spa water is more than 20°F/11°C cooler than the temperature set point, the circulation pump and heater will automatically activate to provide freeze protection. The spa will stay in this mode until the water temperature reaches 15°F/8°C below the set temperature. No corrective action is necessary.
Note: The heater icon  will be blinking and the error icon  will be displayed under the temperature.
11. **Freeze protection:** A potential freeze condition has been detected. No action is required. Jets pump(s) operate until the spa is out of danger. No corrective action is necessary. If condition persists, contact your authorized dealer or service organization.
12. **Overheat protection:** **DO NOT ENTER THE WATER!** Water temperature is above acceptable limits. Heater is deactivated. Remove the spa cover to speed cooling. If condition persists, contact your authorized dealer or service organization.
Note: The heater icon  will be blinking and the error icon  will be displayed under the temperature.





WARNING: RISK OF HYPERTHERMIA (OVER-HEATING) CAUSING SEVERE INJURY, BURNS, OR WELTS.

13. **Overheat protection:** **DO NOT ENTER THE WATER!** Hi-limit temperature is above acceptable limits. Heater is deactivated. Remove the spa cover to speed cooling. If condition persists, contact your authorized dealer or service organization.
Note: The heater icon  will be blinking and the error icon  will be displayed under the temperature.





WARNING: RISK OF HYPERTHERMIA (OVER-HEATING) CAUSING SEVERE INJURY, BURNS, OR WELTS.

14. **Watchdog Protection:** **DO NOT ENTER SPA!** Water temperature is above acceptable limits. Your spa is deactivated. Remove the spa cover to speed cooling. If condition persists, contact your authorized dealer or service organization.
Note: The heater icon  will be blinking and the error icon  will be displayed under the temperature.





WARNING: RISK OF HYPERTHERMIA (OVER-HEATING) CAUSING SEVERE INJURY, BURNS, OR WELTS.

15. Watchdog Protection: **DO NOT ENTER SPA!** Hi-limit temperature is above acceptable limits. Your spa is deactivated. Remove the spa cover to speed cooling. If condition persists, contact your authorized dealer or service organization.



Note: The heater icon  will be blinking and the error icon  will be displayed under the temperature.

 **WARNING: RISK OF HYPERTHERMIA (OVER-HEATING) CAUSING SEVERE INJURY, BURNS, OR WELTS.**

16. Watchdog Freeze Protection: Spa water is below 40°F/4.4°C. Jet pumps operate until the spa is out of danger. Contact your authorized dealer or service organization.

Note: The heater icon  will be blinking and the error icon  will be displayed under the temperature.

17. Controller Overheat Protection: Controller temperature has exceeded acceptable limits. If condition persists, provide shade for equipment side of spa. Contact your authorized dealer or service organization.

Note: The heater icon  will be blinking and the error icon  will be displayed under the temperature.

18. Panel Com Error: The topside controller is having trouble communicating to your spa. Contact your authorized dealer or service organization.

19. Stereo Com Error: The stereo is having trouble communicating to your spa. Contact your authorized dealer or service organization.

20. Wi-Fi Com Error: (not applicable if the optional SmartTub™ system is installed). The Wi-Fi module is having trouble communicating to your spa. Contact your authorized dealer or service organization.

Note: The Wi-Fi icon  will be blinking.

21. CLEARRAY Replacement Reminder: This message will appear when the **CLEARRAY** bulb reminder time has expired (Figure 15.0c). The **CLEARRAY** bulb must be replaced.

22. MicroClean Outer Filter Reminder: This message will appear when the filter reminder time has expired (Figure 15.0d). Remove the MicroClean Outer filters for cleaning or replacement.

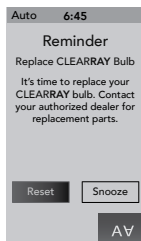

Figure 15.0c

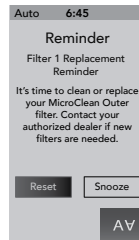

Figure 15.0d

23. **MicroClean Inner Filter Reminder:** This message will appear when the filter reminder time has expired (Figure 15.0e). The MicroClean Inner filter must be replaced.
24. **Water Refresh Reminder:** This message will appear when the “Water Refresh” timer has expired (Figure 15.0f). The water needs to be drained and refilled with fresh water.

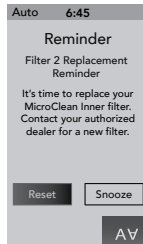

Figure 15.0e

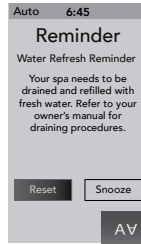



Figure 15.0f

25. **Extended Temperature Activated:** The spa is set to go up to 104°F (40°C), but it can be set to reach 106°F (41°C). To access the extended temperature you need press and hold your finger over the temperature reading for about 5 seconds. The temperature reading will start to blink to indicate the system is ready. Tap ⊕ to raise the temperature up to 106°F (41°C).

Note: The heater icon  will be blinking to indicate that the feature is active.



**WARNING: RISK OF HYPERTHERMIA (OVER-HEATING)
CAUSING SEVERE INJURY, BURNS, WELTS OR DEATH!**

Water temperature in excess of 104°F (40°C) may be injurious to your health.

16.0 Troubleshooting - Procedures

In the unlikely event your hot tub is not working the way you believe it should, please first review all the installation and operating instructions in this manual and check the message on the panel display; second, if you are still not satisfied it is working properly, please follow the appropriate troubleshooting instructions.

PROBLEM

PROCEDURE

None of the components operate (i.e. pump, blower, light)

Check the control panel lights.

1. If there are letters or symbols displayed on the screen, refer to the previous section to determine meaning and action required.
2. If nothing appears on the screen:
 - A. Check the household circuit breaker.
 - B. Contact your Sundance Spas dealer or qualified service technician.

Pump does not operate and icon does

Depress JETS Button.

1. If no sound is detected or if a buzzing sound is detected, turn off power to the spa and contact your authorized dealer or qualified service technician.
2. If motor operates, but now water flows to jets:
 - A. Pump may not be properly primed. See instructions below.
 - B. Contact your Sundance Spas dealer or qualified service technician.

AIR LOCK

Purge "air lock" from circulation pump intake by removing filter cartridge. Hold your garden hose over the filter cartridge wall fitting while using a rag as a seal around hose end. Ask a helper to turn on water for 30 seconds, then turn off. Reinstall filter cartridge and check spa.

Pump Priming Instructions:

This method must be used for the jets pumps because these pumps are not connected to the main filter system in any way.

1. Turn off the power to the spa.
2. Remove the handle from the massage selector supplied by the pump you are priming.
3. Loosen the massage selector's cap slightly (counterclockwise), listening for the air to seep out.
4. Tighten the cap finger tight, replace the handle, and turn the spa's power back on.

CAUTION: If freezing conditions exist and pump is not operational, take measures to protect the system from freeze damage. See Section titled "Winterizing," page 67.

- | | |
|------------------------------------|---|
| Filter/
circulation
pump off | <ol style="list-style-type: none">1. Verify filter/circulation pump is programmed to run 8 hours a day (page 47).2. Hot tub water is warmer than 95°F (35°C) and two degrees warmer than the set temperature. The “Summer Logic” safety feature has activated. |
|------------------------------------|---|

PROBLEM

PROCEDURE

- | | |
|---------------------|--|
| Poor jet
action | <ol style="list-style-type: none">1. Make certain the jets pump is turned on.2. Check position of massage selectors.3. Open air control for selected jet system.4. Check for adequate water level.5. Check for dirty filter (pages 61-63). |
| Water is too
hot | <ol style="list-style-type: none">1. Reduce thermostat setting (page 18).2. Switch hot tub to “Economy” mode to turn heater on only during programmed filter cycles (page 52). |
| No heat | <ol style="list-style-type: none">1. Check thermostat setting.2. Keep the cover in place while heating.3. If “heater on” indicator is lit but no temperature rise is experienced after a reasonable period of time, contact your Sundance Spas dealer or qualified service technician. |

Should checking the above steps fail to correct the problem, please call your authorized dealer so that he may arrange service.

Sundance builds the best hot tubs in the industry. Nonetheless, we are always striving to improve the quality and features of our products. Your input as a Sundance hot tub owner is a cherished part of this process. If you have any comments or suggestions, or if you wish to be informed on any new products for your hot tub, please write to us.

CONGRATULATIONS on your good taste and welcome to the happiest and most relaxed family in the world!

17.0 Typical Hot Tub Wiring Diagrams A-B (North American 60 Hz Models Only)

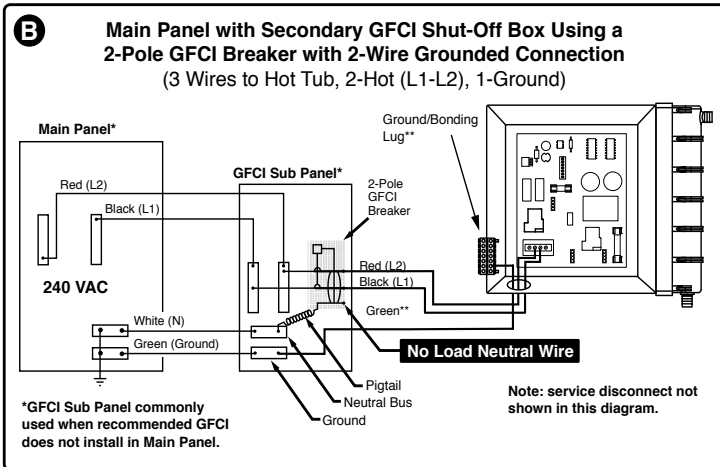
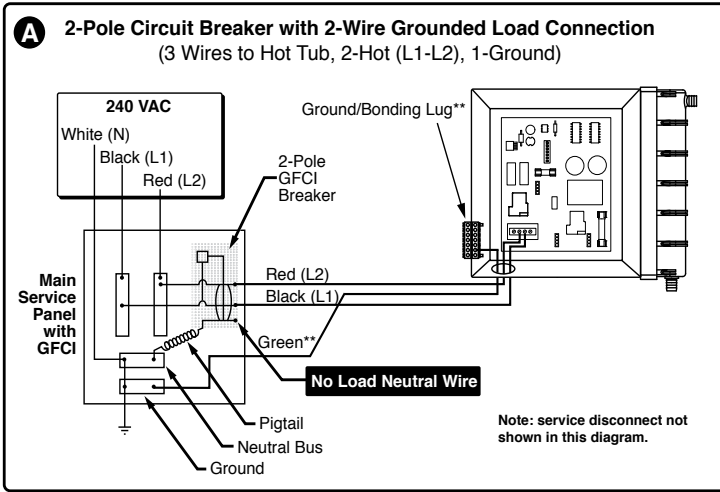

18.0 Circuit Board Electrical Wiring Diagram

18.1 North American 60 Hz Electrical Wiring Diagram for 2-pump models

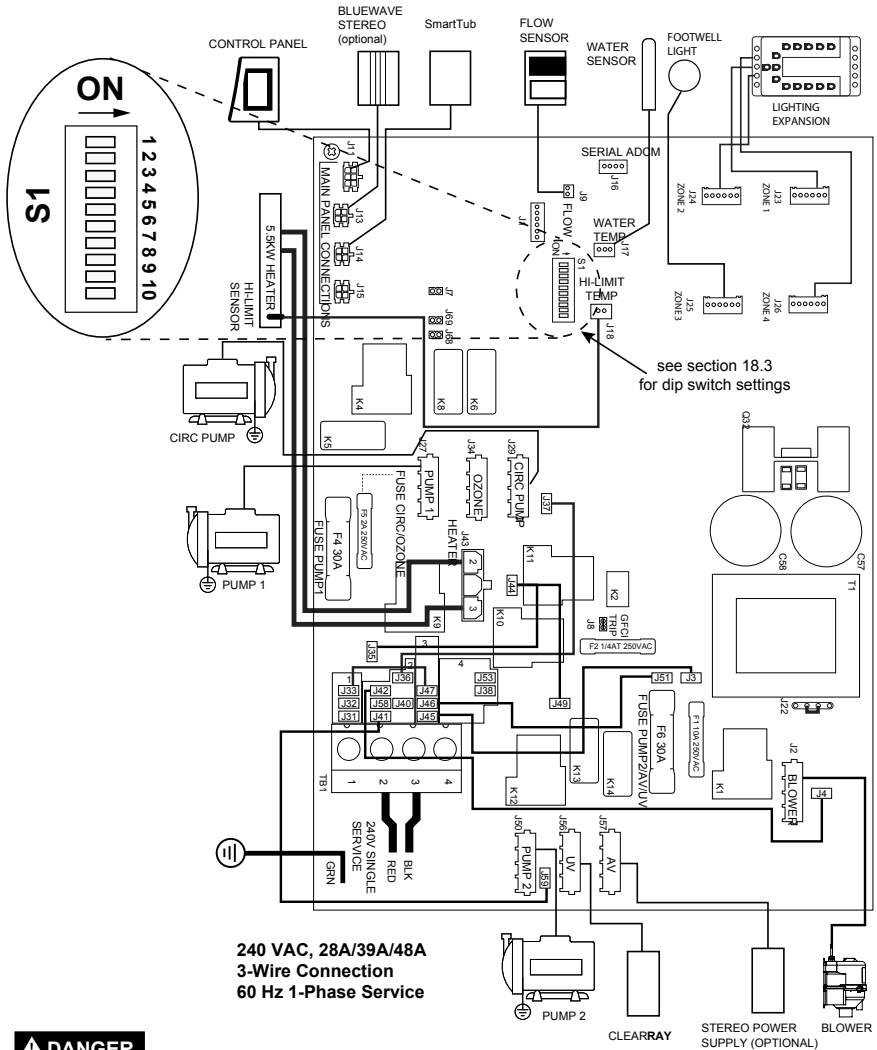

⚠ DANGER
RISK OF SHOCK OR
ELECTROCUTION!

Turn power off
before servicing. This
task should only be
performed by a quali-
fied technician.

18.2 North American 60 Hz Electrical Wiring Diagram for 3-pump models

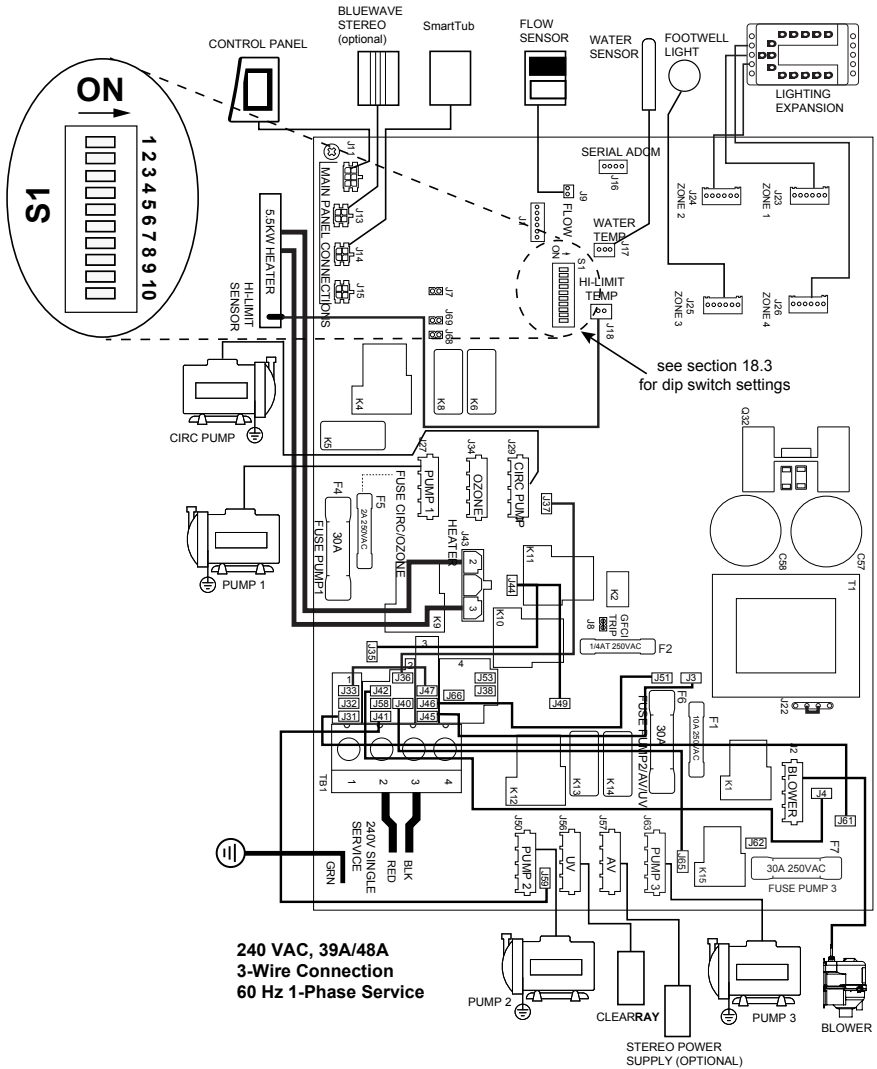

⚠ DANGER
RISK OF SHOCK OR
ELECTROCUTION!

Turn power off
before servicing. This
task should only be
performed by a qual-
ified technician.

18.3 North American 60Hz Dip Switch Settings

A. Settings for a 2-pump system models

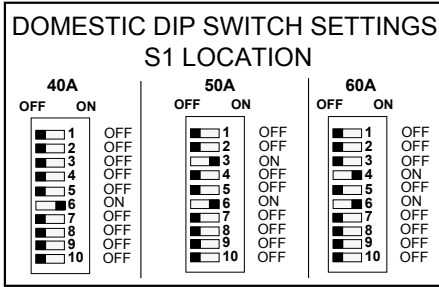

Service Jumper Wiring		
Wire	From	To
1	J37	J36
2	J51	J46
3	J59	J41
4	J44	J49 & J35
5	J33	J47
6	J4	J42
7	J3	J45

BREAKER	DIP SWITCH NUMBER									
	1	2	3	4	5	6**	7	8	9	10
40A	OFF	OFF	OFF	OFF	OFF	ON	OFF	OFF	OFF	OFF
50A*	OFF	OFF	ON	OFF	OFF	ON	OFF	OFF	OFF	OFF
60A	OFF	OFF	OFF	ON	OFF	ON	OFF	OFF	OFF	OFF

*50A is the factory default setting **Dip Switch #6 must be ON.

B. Settings for a 3-pump models

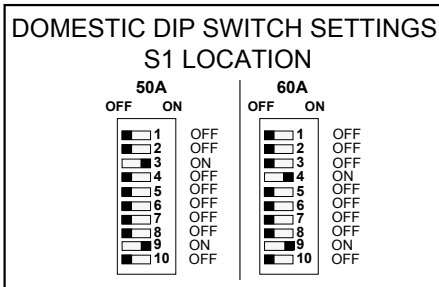

Service Jumper Wiring		
Wire	From	To
1	J37	J36
2	J51	J46
3	J59	J41
4	J44	J49 & J35
5	J33	J47
6	J4	J42
7	J3	J45
8	J31	J61
9	J65	J40

BREAKER	DIP SWITCH NUMBER									
	1	2	3	4	5	6	7	8	9	10
50A	OFF	OFF	ON	OFF	OFF	OFF	OFF	OFF	ON	OFF
60A*	OFF	OFF	OFF	ON	OFF	OFF	OFF	OFF	ON	OFF

*60A is the factory default setting

Dip Switch #9 must be **ON** for 3-pump models

