



P.N.:6530-436C Rev A

# 780™ SERIES OWNER'S MANUAL

Hamilton™ | Chelsea® | Certa® | Montclair™ | Dover™

## Sundance® Spas

# Attention New Spa Owner!

Congratulations on the purchase of your new Sundance® 780 Series spa! The following is a list of automated functions and maintenance recommendations for your new spa. Automated functions have been listed below in an attempt to suppress any operational concerns you may have during startup and the first 24 hours of ownership! Maintenance recommendations are listed in an attempt to stress their importance in protecting your new spa. Spa operation and function are subject to change without notice.

## Automated Operations

Approximately two minutes after power is applied to the spa, the first filtration/heating cycle turns on pump 1 (Section 9.0, page 25). For 2 pump models, an automatic “blow-out” function also activates pump 2 for a period of one minute to flush all lines. Then pump 2 turns off and pump 1 continues to operate for the duration of the cycle.

**Note:** This function only occurs during the first filtration/heating cycle each day.

## Maintain Healthy Spa Water

Always maintain your hot tub’s water chemistry within the following parameters:

	with CLEARRAY®	without CLEARRAY
pH	7.4-7.6	7.4-7.6
Free chlorine	no less than 1.0 ppm	3.0-4.0 ppm
Free Bromine	no less than 2.0 ppm	2.0-4.0 ppm
Total Alkalinity	100-150 ppm	100-150 ppm
Calcium Hardness	150-250 ppm	150-250 ppm

**IMPORTANT:** CLEARRAY® Water Purification System is factory installed. If the CLEARRAY® system is altered or is not operating efficiently then follow the “without CLEARRAY®” water chemistry parameters as defined by the Association of Pool and Spa Professionals. CLEARRAY® requires an annual bulb replacement to properly sanitize your water.



**TO DECREASE RISK OF INFECTION OR DISEASE!** Always maintain your spa filter as outlined below to ensure healthy spa water. Refer to pages 34-35 for additional information.

## Required Filter Maintenance

Your new hot tub is equipped with an advanced 2-stage MicroClean® water filtration system that provides unsurpassed water quality! To ensure maximum water quality at all times, you should clean and reuse the larger pleated filter cartridge every month and replace (throw away) the smaller MicroClean filter cartridge every 3 months, or earlier as necessary. The smaller MicroClean filter cartridge is designed to be thrown away! Attempts to reuse this filter cartridge may result in the re-release of unwanted particles back into the spa. See pages 34-35 for detailed filter cartridge replacement instructions.

## Required Water Maintenance



**TO DECREASE RISK OF INFECTION OR DISEASE!** You should replace the spa’s water every 3 months. The frequency depends on a number of variables including frequency of use, number of users, and attention paid to water quality maintenance. You will know it is time for a change when you cannot control sudsing and/or you can no longer get the normal feel or sparkle to the water, even though the key water balance measurements are all within the proper parameters. See pages 42-43 for additional information.

# Table of Contents

<b>1.0</b>	<b>Important Spa Owner Information</b> .....	<b>1</b>
<b>2.0</b>	<b>FCC Notice</b> .....	<b>1</b>
<b>3.0</b>	<b>Important Safety Instructions for all Spa Owners</b> .....	<b>2</b>
3.1	Entrapment Risk .....	6
3.2	Hyperthermia .....	8
3.3	Important Additional CSA Safety Instructions (Canada Only).....	8
3.4	General Electrical Safety Instructions .....	9
<b>4.0</b>	<b>Choosing A Location</b> .....	<b>10</b>
4.1	Outdoor Location .....	10
4.2	Indoor Location .....	11
<b>5.0</b>	<b>Power Requirements</b> .....	<b>12</b>
5.1	North American 60 Hz Power Options .....	12
5.2	Export 50 Hz Power Options.....	13
<b>6.0</b>	<b>Electrical Wiring Instructions</b> .....	<b>14</b>
<b>7.0</b>	<b>Spa Fill Up Procedure</b> .....	<b>17</b>
<b>8.0</b>	<b>Control Functions</b> .....	<b>23</b>
8.1	Control Panel .....	23
8.2	General Spa Features And Controls .....	24
<b>9.0</b>	<b>Operating Instructions</b> .....	<b>25</b>
9.1	Setting Water Temperature .....	25
9.2	Activate Jets Pumps .....	26
9.3	Selecting Desired Massage Action .....	26
9.4	Air Controls .....	26
9.5	Multi-Colored LED Light Operation .....	27
9.6	Jets .....	27
9.7	Waterfall Operation .....	28
9.8	Optional BLUEWAVE® Spa Stereo System .....	28
<b>10.0</b>	<b>Automatic Filtration Cycles</b> .....	<b>28</b>
10.1	Standard Filtration/Heating Modes (F0-F3) .....	29
10.2	Economy Filtration/Heating Modes (F4-F6).....	29
10.3	Lock Modes (L1-L3).....	29
10.4	Selecting The Filtration/Heating Mode.....	29
10.5	Programming the Circulation Pump Filtration Cycle .....	31
10.6	Programming the CLEARRAY® (Ultraviolet) Water Purification System.....	32
<b>11.0</b>	<b>Spa Maintenance</b> .....	<b>34</b>
11.1	Cleaning The Filter.....	34
11.2	Draining And Refilling.....	36
11.3	Pillow Care.....	37

11.4	Cleaning The Spa Interior .....	38
11.5	Vinyl Cover Care And Maintenance .....	38
11.6	Maintaining The Synthetic Cabinet .....	38
11.7	Winterizing .....	39
11.8	Restarting Your Spa in Cold Weather .....	40
11.9	Replacing the Screws on the EZ Access Door .....	40
11.10	EZ Access Door .....	41
11.11	Stainless Steel Maintenance.....	41
<b>12.0</b>	<b>Water Quality Maintenance .....</b>	<b>42</b>
12.1	pH Control.....	42
12.2	Sanitizing .....	42
12.3	CLEARRAY® Water Purification System.....	43
12.4	CLEARRAY® Bulb Replacement and Quartz Tube Maintenance .....	44
<b>13.0</b>	<b>Error Conditions/Error Messages .....</b>	<b>47</b>
13.1	Summer Logic.....	47
13.2	Overheat Condition .....	47
13.3	Panel displays SN1 .....	47
13.4	Panel displays SN2.....	47
13.5	Panel displays FL1 or FL2 .....	48
13.6	Panel displays COL .....	48
13.7	Panel displays ICE.....	48
13.8	Panel displays - - - .....	49
13.9	Panel displays blb .....	49
<b>14.0</b>	<b>Troubleshooting Procedures.....</b>	<b>49</b>
14.1	None of the Components Operate (e.g. Pump, Light) .....	49
14.2	Pump Does Not Operate but Light Does .....	49
14.3	Poor Jet Action.....	50
14.4	Water is Too Hot.....	50
14.5	No Heat.....	50
<b>15.0</b>	<b>North American Dover Convertible Circuit Diagram .....</b>	<b>51</b>
<b>16.0</b>	<b>North American Certa/Chelsee/Hamilton/Montclair Circuit Diagram .....</b>	<b>52</b>
<b>17.0</b>	<b>Export Dover Circuit Diagram.....</b>	<b>53</b>
<b>18.0</b>	<b>Export Certa/Chelsee/Hamilton/Montclair Circuit Diagram .....</b>	<b>54</b>
<b>19.0</b>	<b>Optional BLUEWAVE® Spa Stereo System .....</b>	<b>55</b>
19.1	Pairing the Remote and Stereo.....	56
19.2	Audio Settings.....	56
19.3	Wireless Remote Control Functions .....	58
19.4	Electronic Device Connections and Functions.....	59
19.5	Wireless Remote Battery Replacement Procedure .....	62
19.6	BLUEWAVE Spa Stereo System Specifications .....	62
19.7	Stereo Cautions .....	63

## **1.0 Important Spa Owner Information**

Your new Sundance® 780 Series Spa is constructed to the highest standards and is capable of providing many years of trouble-free use. However, because heat retentive materials are utilized to insulate the spa for efficient operation, an uncovered acrylic spa surface and wall fittings directly exposed to sunlight and high temperatures for an extended period are subject to permanent damage or discoloration. Damage caused by exposing the spa to this abuse is not covered under warranty. We recommend that you always keep the spa full of water when it is exposed to direct sunlight and that you keep the insulating cover in place at all times when the spa is not in use. Read and carefully follow the requirements for your spa's support base found in Section 4.0 titled, "Choosing a Location" (Page 10).

**We constantly strive to offer the finest spas available, therefore modifications and enhancements may be made which affect the specifications, illustrations and/or instructions contained herein.**

## **2.0 FCC Notice**



This equipment has been tested and found to comply with the limits for a Class B Digital Device, pursuant to Part 15 of the FCC Rules. These limits are designed to provide reasonable protection against harmful interference in a residential installation. This equipment generates, uses and can radiate radio frequency energy and, if not installed and used in accordance with the instructions, may cause harmful interference to radio communications. However, there is no guarantee that interference will not occur in a particular installation. If this equipment does cause harmful interference to radio or television reception, which can be determined by turning the equipment off and on, the user is encouraged to try to correct the interference by one or more of the following measures:



1. Rearrange or relocate the receiving antenna.
2. Increase the separation between the equipment and receiver
3. Connect the equipment into an outlet on a circuit different from the circuit connected.
4. Consult the dealer or an experienced radio/TV technician for help. Changes or modifications not expressly approved by the party responsible for FCC compliance could void the user's authority to operate this equipment.

### 3.0 Important Safety Instructions for all Spa Owners



#### READ AND FOLLOW ALL INSTRUCTIONS CAREFULLY!

This spa was manufactured to meet the standards and specifications outlined in the "Virginia Graeme Baker Pool and Spa Safety Act" (VGB Safety Act). When installing and using this spa, basic safety precautions should always be followed, including:



1.  **DANGER: RISK OF SEVERE INJURY OR DROWNING!**
  - Extreme caution must be exercised to prevent unauthorized access by children.
  - To avoid accidents, ensure that children do not use this spa unless supervised at all times. Adult supervision is a critical safety factor in preventing children from drowning.
  - Use the straps and clip tie downs to secure the spa cover when not in use. This will help discourage unsupervised children from entering the spa. Keep the spa cover secure in high-wind conditions.
  - There is no representation that the cover, clip tie-downs, or actual locks will prevent access to the spa.
  
2.  **DANGER: RISK OF SEVERE INJURY OR DROWNING!**
  - Keep hair, loose articles of clothing or hanging jewelry away from suction fittings, rotating jets or other moving components to avoid entrapment that could lead to drowning or severe injury.
  - Never use the spa unless all suction guards, filter, filter lid, or skimmer assembly are installed to prevent body and/or hair entrapment.
  - Never operate or use the spa if the filter, filter lid, or skimmer assembly are broken or any part of the skimmer assembly is missing. Please contact your dealer or nearest service center for service.
  - The suction fittings and suction covers in this spa are sized to match the specific water flow created by the pump(s). If it is necessary to replace the suction fittings, suction covers or pump(s), be sure that the flow rates are compatible and are in compliance with the VGB Safety Act.
  - Never replace a suction fitting or suction cover with one rated less than the flow rate marked on the original suction fitting. Using improper suction fittings or suction covers can create a body or hair suction entrapment hazard that may lead to drowning or severe injury.

3.  **DANGER: RISK OF SEVERE INJURY FROM ELECTRIC SHOCK OR DEATH FROM ELECTROCUTION!**
- Install the spa at least 5 feet (1.5m), from all metal surfaces. As an alternative, a spa may be installed within 5 feet of metal surfaces if each metal surface is permanently connected (bonded) by a minimum No. 8 AWG (8.4 mm<sup>2</sup>) solid copper conductor attached to the wire connector on the grounding lug, inside the equipment compartment on the equipment box.
  - A grounding wire connector is provided on this unit to connect a minimum No. 8 AWG (8.4 mm<sup>2</sup>) solid copper conductor between this unit and any metal equipment, metal enclosures of electrical equipment, metal water pipe, or conduit within 5 feet (1.5m) of the unit.
  - Never permit any electrical appliance, such as a light, telephone, radio, television, etc. within 5 feet (1.5m) of a spa unless such appliances are built-in by the manufacturer.
  - Never bring any electrical appliances into or near the spa.
  - Never operate any electrical appliances from inside the spa or when you are wet.
  - The electrical supply for this product must include a suitably rated switch or circuit breaker to open all ungrounded supply conductors to comply with section 422-20 of the National Electrical Code/USA, ANSI/NFPA 70. The disconnecting means must be readily accessible and visible to the spa occupant but installed at least 5 feet (1.5m), from the spa.
  - The electrical circuit supplied for the hot tub must include a suitable ground fault circuit interrupter (GFCI) as required by NEC Article 680-42.
4.  **WARNING: RISK OF SEVERE INJURY OR DEATH!**
- Extreme caution must be exercised to prevent diving or jumping into the spa or slipping and falling, which could result in unconsciousness, drowning, or serious injury. Remember that wet surfaces can be very slippery.
  - Never stand, walk or sit on the top railing of the spa.
5.  **WARNING: RISK OF HYPERTHERMIA (OVER-HEATING) CAUSING SEVERE INJURY, BURNS, WELTS OR DEATH!**
- Water temperature in excess of 104°F (40°C) may be injurious to your health.
  - Refer to Section 3.2 Hyperthermia for specific causes and symptoms of this condition.
  - The water in the spa should never exceed 104°F (40°C). Water temperatures between 100°F (38°C) and 104°F (40°C) are considered safe for a healthy adult.
  - Lower water temperatures are recommended for young children (children are especially sensitive to hot water) and when spa use may exceed 10 minutes.

## 780 SERIES

- The Consumer Products Safety Commission/USA has stated that the water temperature in a spa should not exceed 104°F (40°C).
  - Always test the spa water temperature before entering the spa. The user should measure the water temperature with an accurate thermometer since the tolerance of water temperature-regulating devices may vary as much as +/- 5°F (2°C).
6.  **WARNING: RISK OF SEVERE INJURY OR DEATH!**
- Since excessive water temperatures have a high potential for causing fetal damage during the early months of pregnancy, if pregnant or possibly pregnant, consult your physician before using a spa.
  - Pregnant or possibly pregnant women should limit spa water temperatures to 100°F (38°C).
  - Persons suffering from obesity or a medical history of heart disease, low or high blood pressure, circulatory system problems, diabetes, infectious diseases or immune deficiency syndromes should consult a physician before using a spa.
  - If you experience breathing difficulties in association with using or operating your spa, discontinue use and consult your physician.
  - Persons using medication should consult a physician before using a spa since some medication may induce drowsiness, while other medication may affect heart rate, blood pressure, and circulation.
  - Persons suffering from any condition requiring medical treatment, the elderly, or infants should consult with a physician before using a spa.
  - The use of alcohol, drugs, or medication before or during spa use may lead to unconsciousness with the possibility of drowning.
7.  **WARNING: RISK OF SEVERE INJURY OR DEATH!**
- Prolonged immersion in a spa may be injurious to your health.
  - Observe a reasonable time limit when using the spa. Exposures at higher temperatures can cause high body temperature (overheating). Symptoms may include dizziness, nausea, fainting, drowsiness, and reduced awareness. These effects could possibly result in drowning or serious injury.
  - Never use a spa immediately following strenuous exercise. Enter and exit the spa slowly. Wet surfaces can be slippery.



8.  **WARNING: TO DECREASE RISK OF INFECTION OR DISEASE!**
  - To reduce the risk of contracting a waterborne illness (e.g. an infection, bacteria or virus) and/or respiratory ailments, maintain water chemistry within the parameters listed on the inside cover of this manual and consult with a licensed engineer regarding proper ventilation if installed indoors or in an enclosed area.
  - People with infectious diseases should not use a spa to avoid water contamination, which could result in spreading infections to others.
  - Always shower before and after using your spa. Maintain water chemistry in accordance with manufacturer's instructions. Failure to do so may result in contracting a waterborne illness (e.g. an infection, bacteria or virus).
9.  **WARNING:** In addition to maintenance of filters and water chemistry, proper ventilation is recommended to reduce the risk of contracting a waterborne illness (e.g. an infection, bacteria or virus) and/or respiratory ailments that could be present in the air or water. Consult a licensed architect or building contractor to determine your specific needs if installing your hot tub indoors.
10. **CAUTION: TO DECREASE RISK OF PRODUCT DAMAGE.**
  - Maintain water chemistry in accordance with manufacturer's instructions.
  - Proper chemical maintenance of spa water is necessary to maintain safe water and prevent possible damage to spa components.
11. **WARNING: RISK OF SEVERE INJURY OR DEATH!**

The appliance is not intended for use by persons (including children) with reduced physical, sensory or mental capabilities, or lack of experience or knowledge, unless they have been given supervision or instruction concerning use of the appliance by a person responsible for their safety.
12. **NOTE:** This spa is not intended nor designed to be used in a commercial or public application. The spa buyer shall determine whether there are any code restrictions on the use or installation of this spa since local code requirements vary from one locality to another.

## Hot Tub Safety Literature

To ensure you have a safe and enjoyable hot tub experience, learn all you can about hot tub safety and emergency procedures. Especially useful are the brochures listed below:

- [Children Aren't Waterproof](#)
- [Pool and Spa Emergency Procedures For Infants and Children](#)
- [Layers of Protection](#)
- [The Sensible Way to Enjoy Your Spa or Hot Tub](#)

The Association of Pool and Spa Professionals publishes these brochures. To acquire a brochure:

- Ask your hot tub dealer (they may have copies)
- Go to <http://www.apsp.org>
- Conduct your own search on the internet
- Write to the following address:

The Association of Pool and Spa Professionals  
2111 Eisenhower Avenue  
Alexandria VA 22314  
703.838.0083

### 3.1 Entrapment Risk

The Consumer Products Safety Commission/USA has reported that users of pools and spas have become entrapped (stuck) to drain and/or suction fittings causing death, drowning, or serious injury (see diagram below). This spa was manufactured to meet the standards and specifications outlined in the "Virginia Graeme Baker Pool and Spa Safety Act" (VGB Safety Act). Entrapment risk can be minimized if proper precautions are taken.





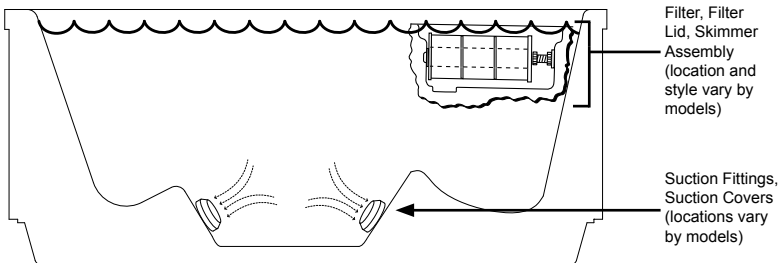

#### **DANGER: RISK OF PERSONAL INJURY OR DEATH!**

Never operate the spa if a suction fitting, suction cover, filter, filter lid or skimmer assembly are broken, damaged or missing.



**NOTE: Suction covers must be replaced every 5 years.**

1.  **DANGER: RISK OF SEVERE INJURY OR DROWNING!**  
**Hair entrapment:** May occur if hair is entangled, knotted or snagged in a drain suction or skimmer assembly. This has been reported in persons who when submerge themselves underwater, allowing hair to come close and/or within the reach of the suction fittings, suction covers or skimmer assembly.
  - Keep hair away from suction fittings, suction covers, filter, filter lid or skimmer assembly.
  - Children are at risk for hair entrapment if swimming under water.
  - Never allow children to play or get near the suction fittings, suction covers, filter, filter lid or skimmer assembly.
2.  **DANGER: RISK OF SEVERE INJURY OR DROWNING!**  
**Limb entrapment:** May occur when a limb becomes entrapped, inserted or sucked into a suction or outlet opening.
  - Always keep suction fittings, suction covers, filter, filter lid or skimmer assembly in place when operating to avoid limb entrapment.
  - Never allow children to play or get near the suction fittings, suction covers, filter, filter lid or skimmer assembly.
3.  **DANGER: RISK OF SEVERE INJURY OR DROWNING!**  
**Body entrapment:** May occur when part of the torso becomes entrapped, inserted or sucked into a suction or outlet opening.
  - Never allow children to play or get near the suction fittings, suction covers, filter, filter lid or skimmer assembly.
4.  **DANGER: RISK OF SEVERE INJURY OR DROWNING!**  
**Evisceration (disembowelment) entrapment:** May occur when the buttocks becomes entrapped, inserted or sucked into a suction or outlet opening.
  - Never sit on suction fittings, suction covers, filter, filter lid or skimmer assembly.
  - Never allow children to play or get near the suction fittings, suction covers, filter, filter lid or skimmer assembly.
5.  **DANGER: RISK OF SEVERE INJURY OR DROWNING!**  
**Mechanical entrapment:** May occur when jewelry, swimsuit, or hair accessories become entangled, knotted or snagged in a drain suction or skimmer assembly.
  - Never allow your jewelry, swimsuit, or hair accessories to come close to the suction fittings, suction covers or skimmer assembly.
  - Never allow children to play or get near the suction fittings, suction covers, filter, filter lid or skimmer assembly.

## **780 SERIES**

### **3.2 Hyperthermia**

Prolonged immersion in hot water may induce hyperthermia (over-heating). The use of alcohol or drugs can greatly increase the risk of fatal hyperthermia in spas. A description of the causes, symptoms, and effects of hyperthermia are as follows:

Hyperthermia occurs when the internal temperature of the body reaches a level several degrees above the normal body temperature of 98.6°F (37°C). The symptoms of hyperthermia include drowsiness, lethargy (fatigue), and an increase in the internal temperature of the body (feeling of being too hot). The effects of hyperthermia include:

- Unawareness of impending hazard;
- Failure to perceive heat;
- Failure to recognize the need to exit spa;
- Physical inability to exit spa;
- Fetal damage in pregnant women; and
- Unconsciousness and DANGER of drowning.

A Warning Sign is provided in your warranty packet. Please install at a location near your spa, where it is visible to users of the spa. For additional or replacement Warning Signs please contact your local Sundance spas dealer and reference item number #6530-082.

### **3.3 Important Additional CSA Safety Instructions (Canada Only)**

When using this electrical equipment, basic safety precautions should always be followed, including the following:

- 1. READ AND FOLLOW ALL INSTRUCTIONS.**
2. A green colored terminal or a terminal marked G, Gr, Ground, Grounding or the  symbol\* is located inside the supply terminal box or compartment. To reduce the risk of electric shock, this terminal must be connected to the grounding means provided in the electric supply service panel with a continuous copper wire equivalent in size to the circuit conductors that supply this equipment (\*IEC Publication 417, Symbol 5019).
3. At least two lugs marked “Bonding Lugs” are provided on the external surface or on the inside of the supply terminal box/compartment. To reduce the risk of electric shock, connect the local common bonding grid in the area of the spa to these terminals with an insulated or bare copper conductor not smaller than No. 6 AWG (10 mm<sup>2</sup>).
4. All field-installed metal components such as rails, ladders, drains or other similar hardware within 10 feet (3m) of the spa shall be bonded to the equipment grounding buss with copper conductors not smaller than No. 6 AWG (10 mm<sup>2</sup>).
- 5. SAVE THESE INSTRUCTIONS.**

### **3.4 General Electrical Safety Instructions**

Your new Sundance® 780 Series Spa is equipped with a "state-of-the-art" equipment system. It contains the most advanced safety and self-protective equipment in the industry. Nonetheless, this spa must be installed properly to ensure dependable usage. Please contact your local Sundance dealer or local building department should you have any questions regarding your installation.

Proper grounding is extremely important. Sundance spas are equipped with a current collector system. A pressure wire connector is provided on the surface of the control box, located outside the equipment door (Figure B, page 16) to permit connection of a bonding wire between this point and any ground metal equipment, metal water pipe or conduit within 5 feet (1.5m) of the spa, or copper clad grounding rod buried within 5 feet (1.5m) of the spa. Bonding wire must be at least No. 8 AWG (8.4 mm<sup>2</sup>) solid copper wire. This is a most important safety assurance feature.

Before installing your spa, check with your local building department to ensure installation conforms to local building codes.

#### **120/240 Volt Dover Convertible Model**

A spa connected to a 120 VAC electrical service must be located close enough to a grounded, grounding-type electrical outlet so that the included 10 feet (3m) power cord can be plugged directly into it. **DO NOT USE AN EXTENSION CORD** as this could cause damage to the spa's equipment due to insufficient voltage. The power supplied to this spa must be a dedicated circuit with no other appliances or lights sharing the power provided by the circuit.

## 4.0 Choosing A Location

**IMPORTANT:** Because of the combined weight of the spa, water and users, it is extremely important that the base upon which the spa rests be smooth, flat, level and capable of uniformly supporting this weight, without shifting or settling, for the entire time the spa is in place. If the spa is placed on a surface which does not meet these requirements, damage to the skirt and/or the spa shell may result. Damage caused by improper support is not covered under warranty. It is the responsibility of the spa owner to assure the integrity of the support over time. We recommend a poured, reinforced concrete slab with a minimum thickness of 4 inches (10 cm). Wood decking is also acceptable provided it is constructed so that it meets the requirements outlined above.



**WARNING:** For spas that are to rest on balconies, roofs or other platforms not specifically tied into main structural support, consult a professional Structural Engineer with experience in this type of application.

The spa must be installed in such a manner as to provide drainage away from it. Placing the spa in a depression without provisions for proper drainage could allow rain, overflow and other casual water to flood the equipment and create a wet condition in which it would sit in. For spas which will be recessed into a floor or deck, install so as to permit access to the equipment, either from above or below, for servicing. Make certain that there are no obstructions which would prevent removal of all side cabinet panels and access to the jets components, especially on the side with the equipment bay doors.



**CAUTION:** If the spa is indoors or located in an enclosed area, proper ventilation should be discussed with an Engineer or authority competent enough to understand the necessary provisions needed to vent moist or heated air and air associated with chemical odors outdoors. **When the spa is in use considerable amounts of moisture will escape potentially causing mold and mildew.** This can cause health risk. Over time, this can damage certain surfaces, surroundings, and equipment.

### 4.1 Outdoor Location

In selecting the ideal outdoor location for your spa, we suggest that you take into consideration the following:

- The proximity to changing area and shelter (especially in regions subject to cold weather).
- The pathway to and from your spa (this should be free of debris so that dirt and leaves are not easily tracked into the spa).
- The closeness to trees and shrubbery (remember that leaves and birds could create extra work in keeping the spa clean).
- A sheltered environment (less wind and weather exposure can result in lowered operation and maintenance costs).

- The overall enhancement of your environment. It is preferable not to place the spa under an unguttered roof overhang since run-off water will shorten the life expectancy of the spa cover.
- For spas that are to rest on balconies, roofs or other platforms not specifically tied into main structural support, consult a professional Structural Engineer with experience in this type of application.
- In the unlikely event that you should ever need to access or gain entry to any portion of the spa for servicing, it is highly recommended that you plan your outdoor installation to provide full access to the entire spa. Please take this into consideration when placing the spa in a deck or enclosed by a surrounding.
- Consider locating your spa away from any reflective surface or glass to prevent any damage to the synthetic skirt.
- Do not shim the spa. To ensure proper support the spa must sit flat on the intended foundation.

#### 4.2 Indoor Location

For indoor installations many factors need to be considered before installing a spa indoors:



**WARNING:** In addition to maintenance of filters and water chemistry, proper ventilation is recommended to reduce the risk of contracting a waterborne illness (e.g. an infection, bacteria or virus) and/or respiratory ailments that could be present in the air or water. Consult a licensed architect or building contractor to determine your specific needs if installing your hot tub indoors.

- **PROPER FOUNDATION: Consult a Structural Engineer when considering a foundation that will adequately support the spa the entire time it is in place.** Proper support is critical especially if the spa is to rest on a second story or higher. For spas that are to rest on balconies, roofs or other platforms not specifically tied into the main structural support, you should consult a professional Structural Engineer with experience in this type of application.
- **PROPER DRAINAGE: It is extremely important to have in place measures to sufficiently handle excessive water spillage.** Be sure the flooring in which the spa rests on has adequate drainage and can handle draining of the entire contents of the spa. Be sure to make provisions for ceilings or any other structures that may be below the spas installation. Areas around your spa can become wet or moist so all flooring and subsequent furniture, walls and adjacent structures should be able to withstand or resist water and moisture.
- **PROPER VENTILATION: Proper ventilation should be discussed with an Engineer or authority competent enough to understand the necessary provisions needed to vent moist or heated air and air associated with chemical odors outdoors.** When the spa is in use considerable amounts of moisture will escape potentially causing mold and mildew, over time this can damage certain surfaces and or surroundings.

## 780 SERIES

- **SUFFICIENT ACCESS:** In the unlikely event that you should ever need to access or gain entry to any portion of the spa for servicing, it is highly recommended that you plan your indoor installation to provide full access to the entire spa.
- **WARRANTY:** Damage caused by not following these guidelines or any improper installation not in accordance with local codes or authorities is not covered under the spas warranty. Please consult your local state or city building ordinances.
- **DO NOT SHIM THE SPA.** To ensure proper support the spa must sit flat on the intended foundation.

## 5.0 Power Requirements

Sundance® spas are designed to provide optimum performance and flexibility of use when connected to the maximum electrical service listed on pages 12-13. If you prefer, your qualified technician can perform a minor circuit board modification to allow your spa to accept an electrical service other than the factory setting.

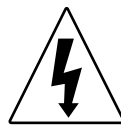

**Note:** Refer to pages 51-54 for circuit board configuration details or contact your authorized Sundance dealer.

### 5.1 North American 60 Hz Power Options

North American Dover Convertible Models (60 Hz)			
	<u>120V/15A*</u>	<u>240V/30A*</u>	<u>240V/40A**</u>
Voltage:	120 VAC	240 VAC	240 VAC
# of Wires:	3 (15A GFCI Cord, US Models Only*)	4 (Hard Wired Only)	4 (Hard Wired Only)
Frequency:	60 Hz	60 Hz	60 Hz
Current Draw:	12A	21A	30A
Circuit Breaker:	15A*, 1-Pole	30A*, 2-Pole	40A**, 2-Pole
<p><b>CAUTION (For 4-wire, 240 VAC Heater Operation):</b> Move the red wire on the main terminal strip (TB1) from position #1 to position #3. Make certain wires are connected exactly as shown in Figure D (page 17) before applying power. Failure to do so will result in damage to the circuit board and/or related components and void the manufacturer's warranty.</p>			
<p>* In the 15A and 30A configuration, the heater <b>will not operate</b> at the same time as the high-speed jets pump. <b>The factory setting is 120V/15A.</b></p>			
<p>** If the spa is to be operated on 40A service, remove the jumper JP1 #1-2 on the circuit board to allow the heater to operate at the same time as the high-speed jets pump (page 51).</p>			



### North American Certa/Chelsee/Hamilton/Montclair 2-Pump Models (60 Hz)

	<u>240V/40A*</u>	<u>240V/50A**</u>	<u>240V/60A***</u>
Voltage:	240 VAC	240 VAC	240 VAC
# of Wires:	3	3	3
Frequency:	60 Hz	60 Hz	60 Hz
Current Draw:	26A	36A	45A
Circuit Breaker:	40A*, 2-Pole	50A**, 2-Pole	60A***, 2-Pole

\* In 40A configuration, the heater **will not operate** while either jets pump is running in high speed. **Note: pump 2 runs only in high speed.**

\*\* In 50A configuration, the heater **will not operate** while both jets pumps are running in high speed. **Note: pump 2 runs only in high speed. This is the factory setting.**

\*\*\* In 60A configuration, the heater **will operate** while both jets pumps are running in high speed. **Note: pump 2 runs only in high speed.**

## 5.2 Export 50 Hz Power Options

### Export 1-Pump Dover Models (50 Hz)

	<u>230V/20A*</u>	<u>230V/30A**</u>
Voltage:	230 VAC	230 VAC
# of Wires:	3	3
Frequency:	50 Hz	50 Hz
Current Draw:	15A	21A
Circuit Breaker:	20A*	30A**

\* In the 20A configuration, the heater **will not operate** while the jets pump is running in high speed. **This is the factory setting.**

\*\* In the 30A configuration, the heater **will operate** while the jets pump is running in high speed.

## 780 SERIES

### Export 2-Pump Certa/Chelsee/Hamilton/Montclair Models (50 Hz)

	<u>230V/20A*</u>	<u>230V/30A**</u>	<u>230V/40A***</u>
Voltage:	230 VAC	230 VAC	230 VAC
# of Wires:	3	3	3
Frequency:	50 Hz	50 Hz	50 Hz
Current Draw:	15A	23A	29A
Circuit Breaker:	20A*	30A**	40A***

- \* In 20A configuration, the heater **will not operate** while either jets pump is running in high speed. **This is the factory setting.** Note: **pump 2 runs only in high speed.**
- \*\* In 30A configuration, the heater **will not operate** while both jets pumps are running in high speed. Note: **pump 2 runs only in high speed.**
- \*\*\* In 40A configuration, the heater **will operate** while both jets pump are running in high speed. Note: **pump 2 runs only in high speed.**

## 6.0 Electrical Wiring Instructions

**IMPORTANT NOTICE:** The electrical wiring of this spa must meet the requirements of the National Electrical Code (NEC) and any applicable state or local codes. The electrical circuit must be installed by a qualified electrician and approved by a local building/electrical inspection authority.

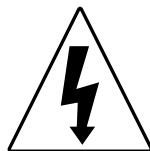

### 1. Convertible 120/240V Powered Dover Models Only:

-  **DANGER: TO DECREASE THE RISK OF SHOCK, PRODUCT DAMAGE OR ELECTRICAL FIRE.**  
**120V "Plug-in" Operation:** This spa must operate on the supplied 10 foot (3m) 120V GFCI cord at its original length or must be hard-wired for longer runs. **NEVER USE AN EXTENSION CORD FOR ANY REASON!**
- Convertible 120/240V Heater Operation: the included 120V GFCI cord must be discarded for 240V heater operation. This spa must be hard-wired. Supplying power to either configuration above which is not in accordance with these instructions will void both the independent testing agency listing and the manufacturer's warranty.

2. Dedicated 240V Power Certa/Chelsee/Hamilton/Montclair Models: These spas must be permanently connected (hard-wired) to the power supply. **No plug-in connections or extension cords are to be used in conjunction with the operation of these spas.** Supplying power to these spas which is not in accordance with these instructions will void both the independent testing agency listing and the manufacturer's warranty.
3. The power supplied to this spa must be a dedicated circuit with no other appliances or lights sharing the power provided by the circuit.
4. To determine the current, voltage and wire size required, refer to Section 5.0 "Power Requirements" (pages 12-13).
  - Wire size must be appropriate per NEC and/or local codes.
  - We recommend type THHN wire.
  - All wiring must be copper to ensure proper connections. **Do not use aluminum wire.**
  - When using wire larger than #6 (10 mm<sup>2</sup>), add a junction box near the spa and reduce to short lengths of #6 (10 mm<sup>2</sup>) wire to connect to the spa.
5. The electrical supply for this product must include a suitably rated switch or circuit breaker to open all ungrounded supply conductors to comply with Section 422-20 of the National Electrical Code, ANSI/NFPA 70. The disconnecting means must be readily accessible and visible to the hot tub's occupant but installed at least 5 feet (1.5m) from the hot tub.
6. The electrical circuit supplied for the spa must include a suitable ground fault circuit interrupter (GFCI) as required by NEC Article 680-42.
7. For Australia/New Zealand, the spa should be supplied through a residual current device (RCD) with a rated tripping current not exceeding 30mA (IEC 60335-2-60).
8. To gain access to the spa's power terminal block, remove the screws securing the cabinet panel on the side of the spa under the controls. Then remove the control box door screws and door (Figures A-B).
9. Select the power supply inlet you want to use (Figure A, page 16). Feed power cable to control box, then install it through the large opening provided in the bottom side of the box.
10. Connect wires, color to color, on terminal blocks TB1 and TB3 (Figures C-F, page 17). **TIGHTEN SECURELY!** All wires must be hooked up securely or damage could result.
11. Install control box door and screws and reinstall the cabinet side panels.

**Figure A  
Equipment Area**

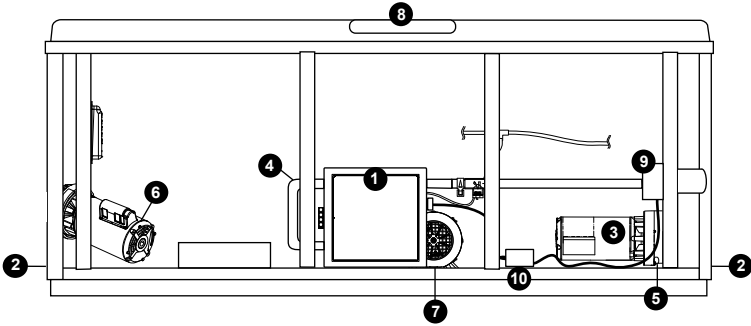

Note: Equipment location (such as pumps, sanitizing system, drain, heater etc.) varies by model.

- |                             |  |
|-----------------------------|--|
| 1. Control Box              | 7. Circulation Pump                                  |
| 2. Power Supply Entrance(s) | 8. Control Panel                                     |
| 3. 2-Speed Pump             | 9. CLEARRAY® (Ultraviolet) Water Purification System |
| 4. Heater                   | 10. Electronic Ballast (for the CLEARRAY System)     |
| 5. Pump Drain Plug          |  |
| 6. 1-Speed Pump             |  |

**Figure B  
Control Box**

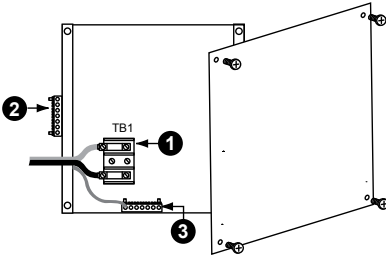

1. Terminal Block
2. Bonding Lug
3. Grounding Terminal

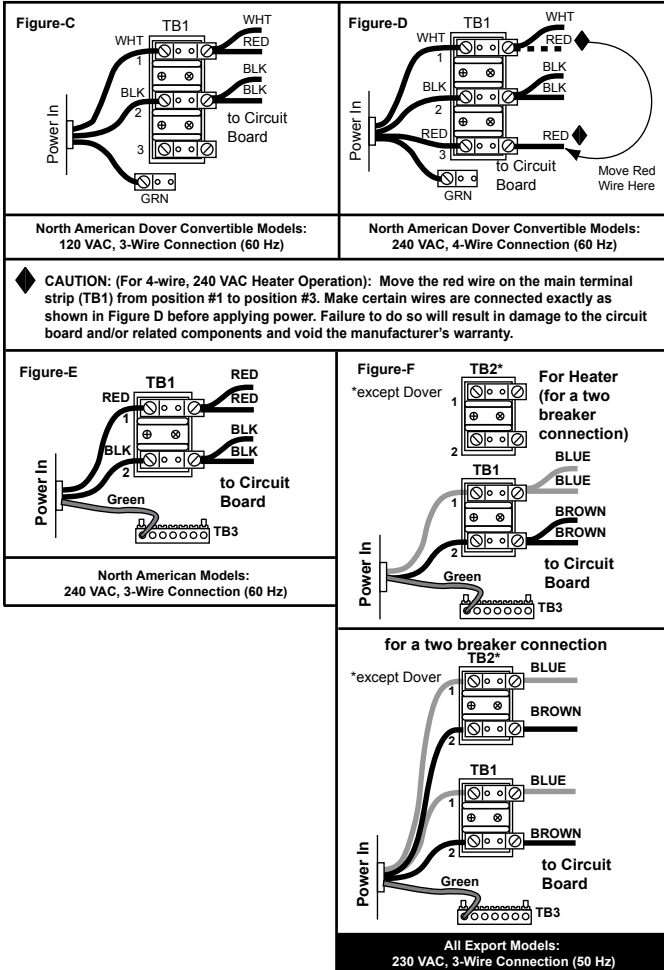

## 7.0 Spa Fill Up Procedure

For best results, read each step in its entirety before proceeding with that step.

### 1. Prepare The Spa For Filling

- Clear all debris from the spa. (Although the spa shell has been polished at the factory, you may want to treat it with a specially formulated spa cleaner.) Consult your dealer for additional information prior to filling spa.
- Remove filter lid (page 24), then remove filter cartridge from filter bucket as illustrated in Section 11.1 (pages 34-35).

### 2. Fill Spa

- Place the end of your garden hose into the empty filter fitting.

**CAUTION: TO DECREASE BUILD UP ON COMPONENTS AND MINIMIZE ACRYLIC DAMAGE.**

Never fill with water from a water softener. If your water is extremely “hard”, it is preferable to fill half-way with hard water and the rest of the way with softened water. Water that is too soft can be corrosive to metal components.



**WARNING: TO DECREASE RISK OF INFECTION OR DISEASE.**

Fill hot tub with clean tap water from garden hose, to reduce risk of contracting a waterborne illness (e.g. an infection, bacteria or virus) and/or respiratory ailments. Fill until water covers all jets but does not touch the bottom of the lowest headrest. (DO NOT OVERFILL!)

**IMPORTANT:** Always fill your spa through the filter fitting after draining. Failure to do so may cause air to be trapped in the pumps, preventing the pumps from circulating water. Remove the hose and replace the filter cartridge as illustrated in Section 11.1 (pages 34-35).

**3. Turn On Power**

Turn on power to spa at the home’s circuit breaker to start boot up sequence (Section 9.0, page 25). The heater and filter/circulation pump will automatically activate after several seconds. If the control panel LED flashes water temperature and “COL” or “ICE” this is normal. Refer to page 48 for additional information.

**Note:** “COL” and “ICE” will only appear when the spa is in Economy mode.

**4. Activate Jets Pumps**

Turn on all jet(s) pumps to ensure proper mixing when adding start-up chemical in step 5.



**5. Add Start-Up Chemicals**

Add the spa water chemicals as recommended by your Sundance dealer. See Section titled “Water Quality Maintenance” (page 42) for general guidance.



**WARNING: RISK OF POISONING OR DEATH.**

**Never leave chemicals opened and accessible to anyone. Use chemicals according to the vendors instructions. Always store chemicals in a safe and/or locked location. Keep away from and out of reach of children.**

## 6. Establish A Stable Sanitizer Reading

Establish a stable sanitizer reading no less than 1.0 ppm chlorine or 2.0 ppm bromine. To ensure healthy water conditions, always maintain a constant sanitizer reading within the levels recommended on the inside cover of this manual. If sanitizer levels cannot be stabilized, perform the decontamination procedure steps 9-15 on the following page.

**Note:** The “decontamination procedure” steps 9-15 should also be used after the spa has been “Winterized” (Section 11.7, page 39) or has been sitting without power for an extended period.

## 7. Set Spa To Heat

To warm spa water to a comfortable temperature, follow these steps:



- The LED display on the control panel displays the actual temperature of the spa water. Press either the **COOLER** (✓) or **WARMER** (▲) button once to display the “set” temperature for 5 seconds. If you want the water to heat to a different temperature, simply press **COOLER** or **WARMER** within 5 seconds. The set temperature increases or decreases by one degree each time one of these buttons is pressed.
- The heater will turn off when the temperature corresponding to the thermostat setting is achieved.

### Important Heater Details:

- The maximum temperature for which the spa can be set is 104°F (40°C) and the minimum is 65°F (18°C).
- For North American 2-pump spas powered by a 40 amp service, jets pump #1 must be set to low speed and jets pump #2 must be turned off to operate the heater.
- For Export (50 Hz) 2-pump spas powered by a 20 amp service, jet pump #1 must be set to low speed and jets pump #2 must be turned off to operate the heater.
- Setting the thermostat at maximum will not accelerate the heating process. This will only result in a higher ultimate temperature.
- The heater operates until the water reaches the programmed “set temperature”, then turns off. The heater will reactivate after the water cools to approximately 1.5° below the “set temperature.”

## 8. Place Cover On Spa

- Keeping the insulating cover in place anytime the spa is not in use will reduce the time required for heating, thereby minimizing operating costs.
- The time required for initial heat-up will vary depending on the starting water temperature.



**DANGER: RISK OF PERSONAL INJURY.**

Check water temperature carefully before entering hot tub! Excessive water temperature can cause burns, welts and body temperature to rise, hyperthermia (over-heating).

**Decontamination Procedure (Steps 9-15)**

Steps 9-15 below are only required when sanitizer levels are unstable after performing steps 1-6 above. Disregard steps 9-15 below if sanitizer levels remain stable at the levels recommended on the inside cover of this manual.

9. Add 2.5 ounces (71 g) of sodium dichlor for every 100 gallons (378 Liters) of water. Refer to the table (page 20) for approximate water fill volume by model.



**CAUTION: RISK OF PERSONAL INJURY OR SPA DAMAGE!**

Never add chlorine tablets (trichlor) or acid to your hot tub for any reason! These chemicals may damage components within your hot tub, burn or irritate your skin, create a rash, and void the manufacturer warranty for your spa.

**Water Fill Capacity**

Model	Average Fill Volume*	Sodium dichlor
Certa.....	364 Gal (1,378 L).....	9.0 oz
Chelsee .....	400 Gal (1,514 L).....	10.0 oz
Dover.....	230 Gal (871 L).....	6.0 oz
Hamilton .....	393 Gal (1,488 L).....	10.0 oz
Montclair .....	310 Gal (1,173 L).....	8.0 oz

\*Use average fill volume for chemical maintenance

10. Leave spa cover open during this step to allow excessive chemical vapors to exit spa, protecting pillows and plastic knobs from chemical attack. If spa is indoors, open doors and windows for proper ventilation. Turn on all spa jets pumps for one hour, open all air controls, and place all massage selector knob(s) in their center "combo" position as shown (right).



**Note:** You will need to press the jets pump button(s) every 20 minutes since these functions have an automatic 20 minute time-out function that turns them off.





**WARNING: BECAUSE OF THE RISK OF INHALING CHEMICAL VAPORS.**

- To decrease the risk of injury, drowning or entrapment, never leave your hot tub unattended for any reason while the cover is open and accessible, especially to small children and animals!
- Precautions should be taken to minimize your exposure to chemical vapors (that could cause lung, brain, or skin damage).

11. Turn off power to the spa at the circuit breaker, then drain spa as outlined in Section 11.2 (pages 36-37).
12. Refill spa with clean tap water from garden hose until water covers all jets but does not touch the bottom of the lowest headrest. (DO NOT OVERFILL!)

**CAUTION: TO DECREASE BUILD UP ON COMPONENTS AND MINIMIZE ACRYLIC DAMAGE.**

Never fill with water from a water softener. If your water is extremely "hard", it is preferable to fill half-way with hard water and the rest of the way with softened water. Water that is too soft can be corrosive to metal components.

13. Consult your authorized Sundance dealer for chemical recommendations, then add chemicals to spa water to achieve a constant sanitizer reading within the levels recommended on the inside cover of this manual.
14. Turn on all jet pumps when adding chemicals to ensure proper mixing and leave your spa cover open until the sanitizer level becomes stable to protect pillows and plastic knobs from chemical attack. Refer to the inside cover of the manual.



**WARNING: RISK OF PERSONAL INJURY.**

- To decrease the risk of injury, entrapment or drowning, never leave your hot tub unattended for any reason, especially if while the cover is open and accessible to small children and animals!
- To decrease the risk of contracting a waterborne illness (e.g. an infection, bacteria or virus) and/or respiratory ailments, maintain water chemistry within 6 step parameters. If you or other bathers experience such a condition, discontinue use and seek immediate medical attention.

## **780 SERIES**

15. Establish a sanitizer reading no less than 1.0 ppm free chlorine or 2.0 ppm bromine, then allow the hot tub to set undisturbed for 8 hours. Retest water after 8 hours to determine if sanitizer levels are stable. If sanitizer levels are stable, your spa is ready for use. To ensure healthy water conditions, always maintain a constant sanitizer reading within the levels recommended on the inside cover of this manual. If sanitizer levels are not stable at this time, it will be necessary to repeat this procedure in its entirety (steps 1-15) until stable sanitizer readings are achieved.

**IMPORTANT:** If the CLEARRAY® water purification system is removed from the hot tub or is not operating effectively follow the “without CLEARRAY®” water chemistry parameters as defined by the Association of Pool and Spa Professionals.



16. After adequate sanitizer levels are achieved, close all spa air controls to maximize heat retention when spa is not in use.

## 8.0 Control Functions

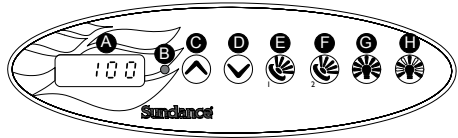
### 8.1 Control Panel



2 Pump Panel Shown

- A. **LED Display:** Can display current water temperature (default display), water temperature set point, selected filtration/heating mode, and error messages.
- B. **Heat Indicator:** Lit when heater is on.
- C. **Warmer (  ) Button:** Increases water temperature set point.
- D. **Cooler (  ) Button:** Decreases water temperature set point.
- E. **Jets 1 Button:** Turns jets pump #1 on and off. Press once for low speed; press a second time for high speed; press a third time to turn pump #1 off.
- F. **Jets 2 Button (if equipped):** Turns high-speed jets pump #2 on and off. Press once to turn on; press a second time to turn pump #2 off.
- G. **Light On/Off Button:** Turns waterfall, footwell, and LED accent lights on in unison. Press once for high intensity; press a second time for medium intensity; press a third time for low intensity; press a fourth time to turn off. The displayed color is changed using the light mode button (H) below.
- H. **Light Mode Button:** Selects one of 4 color modes for waterfall, footwell, and air control lights. See page 27 for additional information.

### Operation Details

- Temperature Adjustment: 65-104°F (18-40°C). Factory default setting is 100°F (38°C).
- All lighting systems run for 2 hours then shut off.
- Jets 1/Jets 2 Button Operation: Jets run for 20 minutes after activated, then turn off automatically to conserve energy. Simply press either jets button to continue operation for an additional 20 minutes.

## 780 SERIES

### 8.2 General Spa Features And Controls

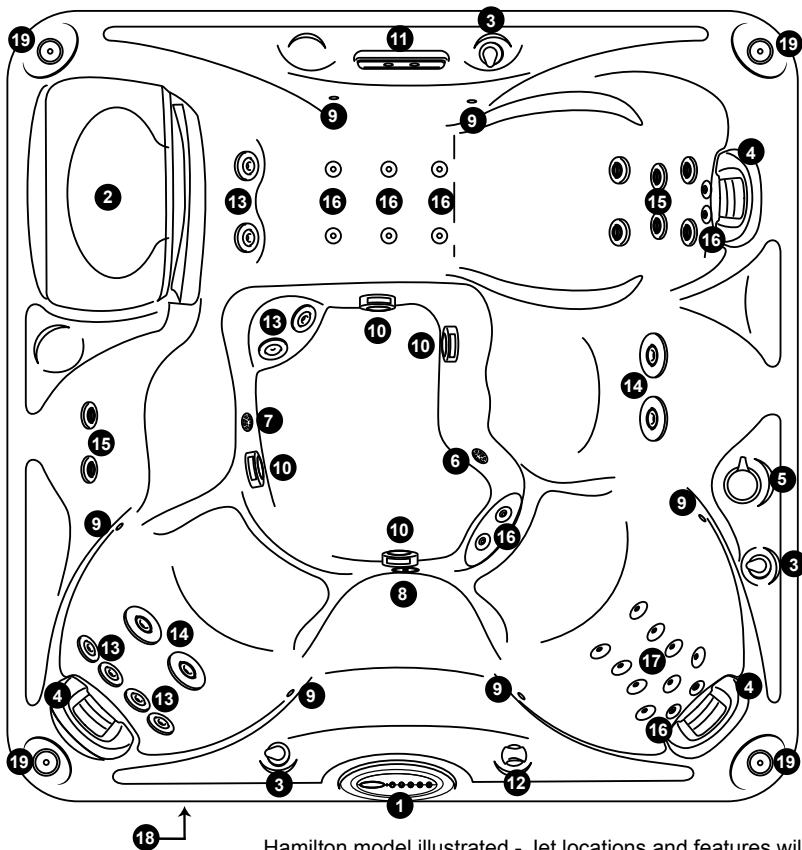

Hamilton model illustrated - Jet locations and features will vary by model. Spa features subject to change without notice.

- |   |   |
|---|---|
| 1. Control Panel  | 12. Waterfall Control (On/Off)                |
| 2. Filter Lid and Filter Cartridge                      | 13. Mini-Vortex Jets (8)                      |
| 3. Air Controls (3)                                     | 14. Vortex Jets (4)                           |
| 4. Pillows (3)  | 15. SMT Fluidix Jets (8)                      |
| 5. Massage Selector                                     | 16. SMT Micro Jets (12)                       |
| 6. Gravity Drain/Ozone Return/<br>Heater Return Fitting | 17. Accu-Pressure Jets (9)                    |
| 7. Waterfall overflow                                   | 18. Optional BLUEWAVE® Spa<br>Stereo System   |
| 8. Spa Light  | 19. Optional Audio System Speakers,<br>4 each |
| 9. Multiple LED Accent Lights (6)                       |   |
| 10. Suction Fittings (4)                                |   |
| 11. Waterfall w/LED Light                               |   |

## 9.0 Operating Instructions

The spa control system has automatic functions that operate upon startup and normal operation to protect the system. Upon power up, the readout displays the following information:

1. Control panel displays current software release.
2. Control panel displays "888" and all indicator LEDs are lit, permitting visual inspection of all display segments and indicator lights for proper operation.
3. After the initial start-up sequence ends, the actual water temperature is displayed. If water temperature at this time is less than the factory default temperature setting of 100°F (38°C) and the spa is set to either of the standard filtration/heating modes (page 29), the heater will turn on and run until the water temperature rises to the factory setting, then turn off.

**Note:** It is common for the heater to turn on after the spa is first filled because tap water is often very cold.

4. Approximately two minutes after power is applied to the spa, the first filtration/heating cycle turns on pump 1. For 2 pump models, an automatic "blow-out" function also activates pump 2 for a period of one minute to flush all lines. Then pump 2 turns off and pump 1 continues to operate for the duration of the cycle.

**Note:** This function only occurs during the first filtration/heating cycle each day.

### 9.1 Setting Water Temperature

The spa's thermostat provides optimum control of water temperature. The temperature setpoint (set temperature) can be adjusted from 65-104°F (18-40°C). To raise the set temperature, press the **WARMER** (▲) button. To lower the set temperature, press the **COOLER** (▼) button. The first press of either button displays the set temperature. To access the overtemp feature that allows the spa to reach 106°F (41°C) follow the steps below (Figure 1).

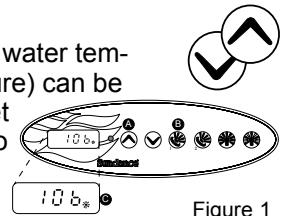

Figure 1



**WARNING: RISK OF HYPERTHERMIA (OVER-HEATING) CAUSING SEVERE INJURY, BURNS, WELTS OR DEATH!**

Water temperature in excess of 104°F (40°C) may be injurious to your health.

- A. Press and hold the **WARMER** (▲) button then;
- B. Press and hold the **JETS 1** (🌀) button at the same time for 2 seconds. You will see the temperature rise to 106°F (41°C) on the LED display. To lower the temperature, press the **COOLER** (▼) button.

## 780 SERIES

- C. When the overtemp has been activated, the decimal point after the last digit will flash on and off every second as an indicator for being in the overtemp mode.

**Note:** Once the temperature goes below 104°F (40°C) and you would like to raise the temperature to 106°F (41°C) again, you will have to repeat the steps above.

### 9.2 Activate Jets Pumps

The **JETS 1** button activates the functions of the main 2-speed jets pump. The first press activates pump 1 in low speed, the second press activates high speed, and the third press shuts the pump off. For 2-pump models, the **JETS 2** button controls jets pump 2 which only operates in high speed. When manually activated, both pumps automatically turn off in 20 minutes.



### 9.3 Selecting Desired Massage Action

Your Sundance spa is equipped to allow you to customize the massage action you desire. Each model incorporates a massage selector that allows you to customize the massage and performance by diverting water between various jet systems. Simply turn massage selector to position A (Combo), B, or C to divert water pressure to various jet groups.

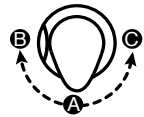

**Note:** The massage selector is designed to operate in positions A (Combo), B, and C for optimum performance. It is considered normal for sound levels within the valve to vary between positions due to the large amounts of water flowing through it. For optimum filtration benefits, leave the valve in position A when spa is covered. Select position B or C for maximum jet performance during spa use.

### 9.4 Air Controls

Certain jet systems have their own air control. Each control introduces air into the water lines that supply specific jet groups. Simply rotate any air control knob clockwise to open, or counterclockwise to close.



**Note:** To minimize heat loss, close all air controls when spa is not in use. Certain jets may not draw air while the jets pump is running in low speed; this is considered normal.



### 9.5 Multi-Colored LED Light Operation

- A. Pressing the LIGHT button activates the footwell, waterfall, and LED accent lights in sequence as follows: High - Medium - Low - Off.

Anytime the light system has been manually activated, it will automatically turn off after approximately 2 hours. If at this time you desire more light operation, simply turn the light system back on.

- B. This button offers four light modes for your enjoyment. Press the LIGHT MODE button to select your favorite lighting effect as follows:

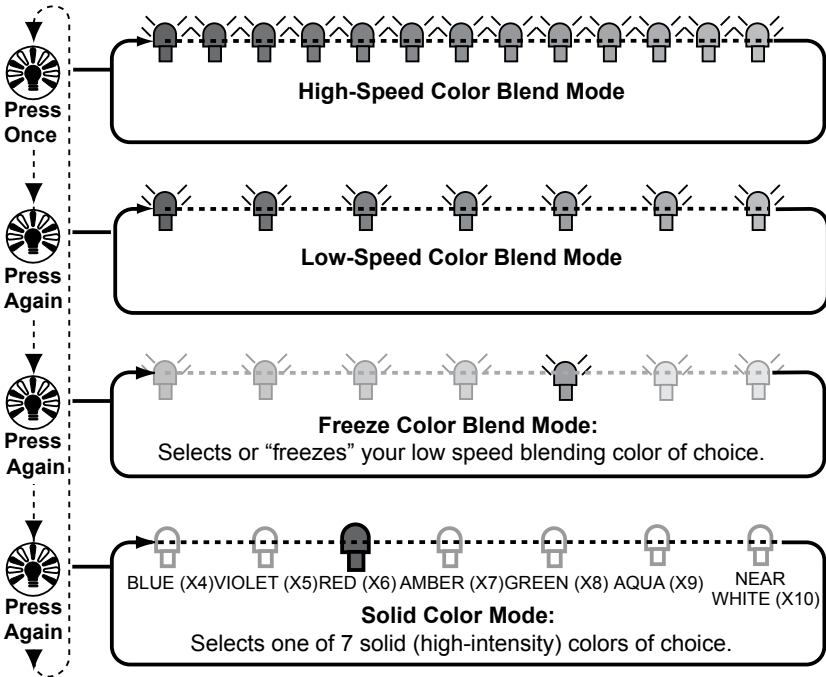

### 9.6 Jets

The water flow through certain jets in your spa can be adjusted or turned off by rotating the outside jet ring. Other jets offer an adjustable center nozzle that allows you to change the water discharge angle. Simply tilt the center nozzle in these jets to the desired angle to customize your personal massage.

**Note:** Always keep at least 6 adjustable jets open at all times on each jet system.



SMT Micro Jet



SMT Fluidix Jet



Mini Vortex Jet

## 780 SERIES

### 9.7 Waterfall Operation

Turn waterfall control valve counterclockwise to increase waterfall output. Turn control valve clockwise to decrease or turn off waterfall output. For the Hamilton, Chelsea, Certa and Montclair models: the waterfall is on whenever the circulation pump is running. For the Dover model: the waterfall is on when jets pump 1 is on.

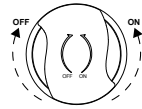

**Note:** It takes half of a revolution to change the waterfall from a full off to a full on flow rate. When the waterfall is in the OFF position some water may still flow through. This is considered normal.

### 9.8 Optional BLUEWAVE® Spa Stereo System

Spas equipped with the optional audio system offer enhanced spa enjoyment. These models include a high-quality FM/iPod®/USB/Bluetooth stereo receiver with four high-quality marine speakers for unsurpassed sound quality and long-life.

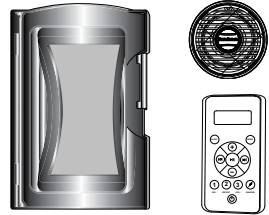

**Note:** The DRM (Digital Rights Management) Files cannot be played on this deck. Personal files (MP3, WMA, iTunes or AAC) can be played as long as they are not DRM encrypted.

## 10.0 Automatic Filtration Cycles

### A. For Certa, Chelsea, Hamilton and Montclair Models

Your new spa includes an 8-hour circulation pump, which filters the water continuously. The circulation pump draws water through the short side of the double-ended filter cartridge and effectively removes small debris in your spa.

**Note:** The 8-hour circulation pump system also supplies heated water to the spa when the heater turns on. To set a time for the first filtration/heating cycle, simply turn power on to the spa two minutes prior to the desired time.

### B. For Dover Models

Your new spa includes a 24-hour circulation pump, which filters the water continuously. The circulation pump draws water through the short side of the double-ended filter cartridge and effectively removes small debris in your spa.

**Note:** The 24-hour circulation pump system also supplies heated water to the spa when the heater turns on. To set a time for the first filtration/heating cycle, simply turn power on to the spa two minutes prior to the desired time.



The control system activates a programmable “Standard” or “Economy” filtration/heating cycle to remove larger debris missed by the circulation pump filtration system. These cycles utilize pump #1 and the larger filter cartridge end to quickly clear “skim” the water of large debris and minimize their “bath-tub ring” effect. Apart from their filtration benefit, each mode also effects the operation of your spa’s heater. Refer to Sections 10.1 and 10.2 below for additional information.

### **10.1 Standard Filtration/Heating Modes (F0-F3)**

Standard filtration/heating modes are typically selected by customers in cold climates where heat up times are extended due to lower ambient temperatures. In these modes, the set temperature regulates the water temperature throughout the day. The heater will activate as needed throughout the day. After the programmed set temperature is reached, the heater turns off.

### **10.2 Economy Filtration/Heating Modes (F4-F6)**

Economy filtration/heating modes are typically selected by customers in warm climates where heat up times are minimized due to higher ambient temperatures. In these modes, the set temperature regulates the water temperature only during a programmed filter cycle. The heater will turn on only when there is a heat call during a programmed filter cycle.

**Note:** These modes consume less energy than standard modes F0-F3 outlined above.

### **10.3 Lock Modes (L1-L3)**

These modes are designed for use during spa service or to prevent unauthorized use.

### **10.4 Selecting The Filtration/Heating Mode**

Press and hold both control panel **WARMER** (▲) and **COOLER** (▼) buttons **at the same time**, then release. Then press either **WARMER** (▲) or **COOLER** (▼) button to select filtration/heating mode F0-F6 or lock modes L1-L3 outlined below. During the filtration/heating cycle the jets pump 1 low speed will activate.

**Note:** (For 2 pump models) At the beginning of the first filtration/heating cycle of the day, an automatic one minute “blow-out” function also activates pump 2 for a period of one minute to flush all lines. Then pump 2 turns off and pump 1 continues to operate for the duration of the cycle.

## 780 SERIES

### Standard Filtration/Heating Modes

- F0** No filtration per day (one minute “blow-out” cycle every 24 hours to purge all plumbing lines)
- F1** 1 hour of filtration per day (one 30-minute cycle every 12 hours); this is the factory default setting.
- F2** 1.5 hours of filtration per day (one 30-minute cycle every 8 hours)
- F3** 2 hours of filtration per day (one 30-minute cycle every 6 hours)

### Economy Filtration/Heating Modes

- F4** 1 hour of filtration/heating per day (one 30-minute cycle every 12 hours)
- F5** 1.5 hours of filtration/heating per day (one 30-minute cycle every 8 hours)
- F6** 2 hours of filtration/heating per day (one 30-minute cycle every 6 hours)

### Lock Modes

(When in a lock mode the display will flash between the temperature and the Lock mode number)

- L1** Lock Out (disables all spa functions to permit filter cleaning)

**Note:** The spa should not be left in this lock mode for an extended period of time. Especially in colder climates or when freezing conditions exist.

- L2** Lock Mode (disables the jets to prevent unauthorized use of spa). Filtration/heating cycle will continue to operate as programmed in this mode. The temperature display flashes when this function is enabled. Example: the “F3” filtration/heating cycle was enabled prior to choosing lock mode. The spa continues to perform the “F3” cycle until lock mode is canceled, allowing another cycle to be selected.

- L3** Lock Mode (disables the temperature up and down buttons to prevent unauthorized temperature adjustments). Filtration/heating cycle will continue to operate as programmed in this mode. The jets and lights buttons will still continue to operate as normal. The temperature display flashes when this function is enabled.



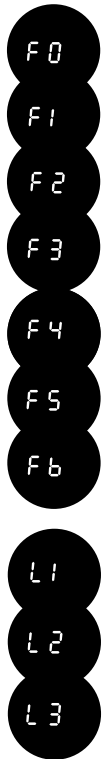

**Note:** To exit a lock mode you will need to re-enter the filtration/heating modes and select a new cycle from F1-F6.

To set a time for the first filtration/heating cycle, simply turn power on to the spa two minutes prior to the desired time. Example: If you desire your first filtration/heating cycle to begin at 10:00 AM turn off power to the spa and turn it back on again at 9:58 AM. You can also press the Warmer, Cooler and Jets Pump 1 buttons simultaneously for 2 seconds to restart the spa.

**Note:** Start time is approximate and may vary slightly from day to day.



### 10.5 Programming the Circulation Pump Filtration Cycle

Press and hold the **Jets pump 1** (  ) and **Cooler** (  ) button at the same time for 3 seconds to access the circulation pump programming. Continually press the **Warmer** (  ) button to scroll up through the cycles below. Then select a cycle and press the **Jets pump 1** (  ) button to activate that cycle. Upon pressing the jets pump 1 button the system will save your selection, exit the program menu and return to the main menu.

#### Note:

- Any time the circulation pump runs (e.g. when heating) outside of a programmed cycle, that run time will reduce the length of the next cycle.
- After 10 seconds the programming screen will revert back to the temperature if no buttons are pressed. You cannot have more than one circulation pump cycle activated at a time.

[0]

0 hours of circulation per day

[1]

4 hours of circulation per day

[2]

8 hours of circulation per day (recommended factory default setting **for Certa, Chelsee, Hamilton and Montclair models**)

[3]

12 hours of circulation per day

[4]

16 hours of circulation per day

[5]

20 hours of circulation per day

[6]

24 hours of circulation per day (recommended factory default setting **for Dover models**)

**In extreme bitter cold weather we recommend you program the circulation pump to run 24 hours. Refer to the "Winterizing" section on page 39.**

To set a time for the first filtration/heating cycle, simply turn power on to the spa two minutes prior to the desired time. Example: If you desire your first filtration/heating cycle to begin at 10:00 AM turn off power to the spa and turn it back on again at 9:58 AM. Start time is approximate and may vary slightly from day to day. You can also press the Warmer, Cooler and Jets Pump 1 buttons simultaneously for 2 seconds to restart the spa.

## 780 SERIES

### For Certa, Chelsee, Hamilton and Montclair models:

The recommended factory default setting is **8 hours**. This setting should not be altered to run for less than 8 hours. Running the circulation pump less than the factory recommended time would result in issues with water quality maintenance.

**Note:** If the circulation pump filtration cycle is interrupted or turned off the duration of the cycle will not be extended once spa functions resume. Example: If the spa is set to cycle for 8 hours and only runs for 2 hours before the interruption, once functions resume it will not continue to cycle for another 6 hours, if the 8-hour cycle time has expired.

### For Dover models:

The recommended factory default setting is **24 hours**. This setting should not be altered. Running the circulation pump less than the factory recommended time would result in issues with water quality maintenance.

## 10.6 Programming the CLEARARRAY® (Ultraviolet) Water Purification System

### A. Programming the CLEARARRAY System (U) or Corona Discharge Ozone (O3)

Press and hold the **Jets pump 1** (☰) and **Cooler** (☑) button at the same time for 3 seconds. Scroll pass the circulation pump programming menus by pressing the Warmer button, Figure 1.

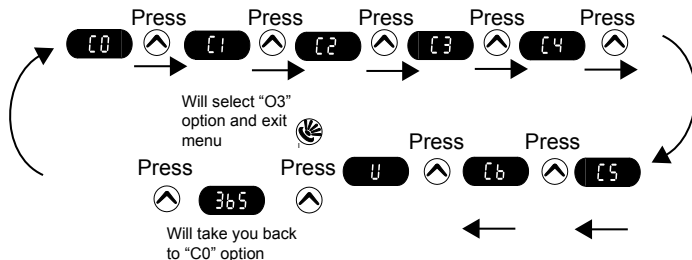

1. After the last cycle, "C6", the LED screen will display "U" or "O3." If the LED screen is displaying "U" then pressing the Jets pump 1 will change the sanitizing system from "U" to "O3" and exit the programming menu. If the LED screen is displaying "O3" then pressing the Jets pump 1 will change the sanitizing system from "O3" to "U" and exit the programming menu. You will see one of the two configurations below:
  - a. C0, C1, C2, C3, C4, C5, C6, U, 365 (duration countdown timer)
  - b. C0, C1, C2, C3, C4, C5, C6, O3, =

**Note:** For the O3 option the "=" disables the duration countdown timer.

2. If you do not wish to change the option do not press any buttons and after 10 seconds the display will return to the main menu.





**Note:** If the CLEARRAY System has been selected, when the time allotted has expired (365 days) the display screen will flash between the water temperature and “blb.” At this time the UV bulb must be replaced, the quartz tube must be cleaned and the duration countdown timer needs to be reset.

### B. Resetting the duration countdown timer (CLEARRAY System only)

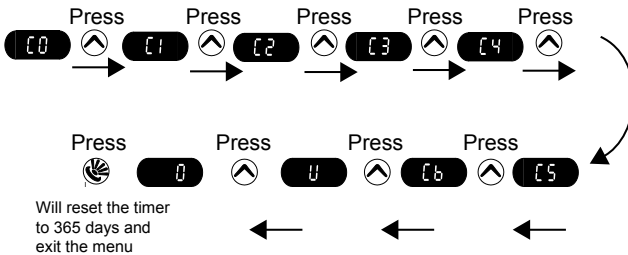
Once the duration countdown timer for the CLEARRAY System has reached zero, you will need to reset it, replace the UV bulb and clean the quartz tube.

To reset the duration countdown timer:



1. Press and hold the **Jets pump 1** (  ) and **Cooler** (  ) button **at the same time** for 3 seconds.
2. Press the **Warmer** (  ) button until the display shows “0.”
3. If the counter has reached “0”, pressing the **Jets pump 1** (  ) button will reset the timer. **If the timer is not at “0” pressing the Jets pump 1 will not reset it.**

**Note:** If the spa power is interrupted, the duration countdown timer is not affected. The number of days remaining is stored in the memory and will continue to countdown once power is regained.

4. If the duration countdown timer is not at “0” and you need to reset it:
  - a. Press and hold the Jets pump 1 and Cooler buttons at the same time for 3 seconds.
  - b. Press the Warmer button to scroll to “U.”
  - c. Press the Jets pump 1 button to switch from “U” to “O3.”
  - d. Press and hold the Jets pump 1 and Cooler buttons at the same time for 3 seconds.
  - e. Press the Warmer button to scroll to “O3.”
  - f. Press the Jets pump 1 button to switch from “O3” to “U.” The timer has been reset to 365 days.

## 780 SERIES

### 11.0 Spa Maintenance

Proper and regular maintenance of your spa will help it retain its beauty and performance. Your authorized Sundance dealer can supply you with all the information, supplies and accessory products you will need to accomplish this.



#### **DANGER: RISK OF SEVERE INJURY OR DROWNING BY ENTRAPMENT!**

- Keep hair, loose articles of clothing or hanging jewelry away from suction fittings, rotating jets or other moving components to avoid entrapment that could lead to drowning or severe injury.
- Never use the spa unless all suction guards, filter, filter lid, or skimmer assembly are installed to prevent body and/or hair entrapment.
- Never operate or use the spa if the filter, filter lid, or skimmer assembly are broken or any part of the skimmer assembly is missing. Please contact your dealer or nearest service center for service.
- The suction fittings and suction covers in this spa are sized to match the specific water flow created by the pump(s). If it is necessary to replace the suction fittings, suction covers or pump(s), be sure that the flow rates are compatible and are in compliance with the VGB Safety Act page 2.
- Never replace a suction fitting or suction cover with one rated less than the flow rate marked on the original suction fitting. Using improper suction fittings or suction covers can create a body or hair suction entrapment hazard that may lead to drowning or severe injury.
- Owners must alert all spa users to the potential risk of Hair, Limb, Body, Evisceration (disembowelment), and Mechanical Entrapment, page 6.

#### 11.1 Cleaning The Filter

Your new spa is equipped with an exclusive MicroClean® 2-stage filter cartridge located under the filter lid. Fine debris are filtered by the circulation pump drawing water through the ultra-fine (stage 2) cartridge. Larger debris are filtered by the main 2-speed pump drawing water through the (stage 1) polyester mesh (pleated) cartridge during normal operation and during each filtration/heating cycle. Combined, both filter halves work together to give you unsurpassed water quality by trapping suspended particles on their outer surface.

**Note:** To ensure optimum performance, clean and reuse the stage 1 cartridge once a month and replace the stage 2 cartridge every 3 months, or as needed.

**⚠ DANGER: TURN POWER TO SPA OFF! TO DECREASE RISK OF DEATH, DROWNING, OR ENTRAPMENT, NEVER OPERATE SPA WHEN FILTER IS NOT PROPERLY INSTALLED OR IF SKIMMER ASSEMBLY IS DAMAGED OR ALTERED!**

Refer to the filter cleaning/replacement procedure:

**A**



**TURN POWER TO HOT TUB OFF!**



**B**

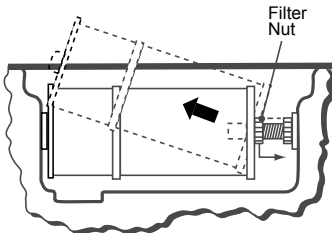

Loosen filter nut to provide clearance, then remove filter assembly.

**C**

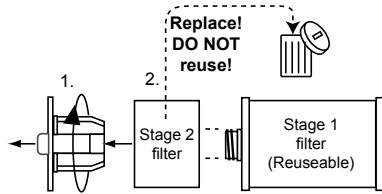

1. Rotate stage 2 retainer counterclockwise to release, then separate filter assembly.
2. Replace (throw-away) stage 2 filter after 3 months use or as needed. **DO NOT REUSE!**

**D**

Note: Remove and clean the Stage 1 filter cartridge once a month.

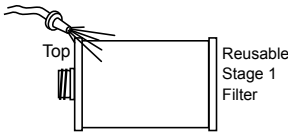

Rinse debris from all filter pleats using a garden hose and high-pressure nozzle. Start at top and work downward to face. Repeat process until all filter pleats are clean.

**E**

Note: The Stage 2 filter cartridge cannot be cleaned and must be (thrown out) replaced every 3 months, or as needed.

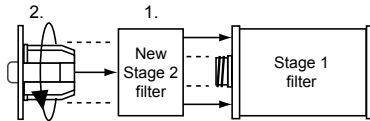

1. Install new stage 2 filter onto clean stage 1 filter.
2. Insert retainer into stage 2 filter and rotate clockwise to assembly. **DO NOT OVERTIGHTEN RETAINER (FINGER TIGHT ONLY)!**

**F**

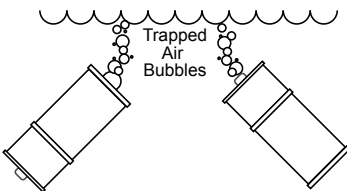

Submerge assembled filter in spa and tilt each end upward to remove trapped air bubbles from inside each filter cavity.

**G**

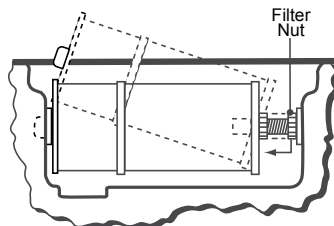

1. Install filter assembly, then tighten filter nut so it just touches filter face. **DO NOT OVERTIGHTEN!**
2. Turn power to hot tub back on.

## 780 SERIES

Periodically, the polyester mesh (pleated) filter will need a more thorough cleaning to remove imbedded oils and minerals. For this, we suggest cleaning as illustrated above (step D), followed by soaking the filter overnight in a plastic container filled with a solution of water and a specially formulated filter cleanser available from your Sundance dealer.

### **CAUTION: RISK OF PRODUCT DAMAGE!**

- Never scrub the polyester mesh filter cartridge with a brush as this will cause the polyester mesh to wear out and come apart.
- Never let the spa pump run or have a filter cycle come on without a filter cartridge in the skimmer compartment. Running the spa without a filter cartridge may permit debris to enter the spa plumbing and void the warranty!

The average life expectancy of the polyester mesh filter cartridge is approximately two years with proper care and water quality maintenance. The smaller stage 2 filter cannot be cleaned and must be replaced (thrown-out) every 3 months, or as needed. **DO NOT** reuse this cartridge! Attempts to reuse this cartridge will reintroduce debris back into your spa! Replacement cartridges may be purchased from your Sundance dealer.

## 11.2 Draining And Refilling

About every 3 months, you will want to replace the spa's water. The frequency depends on a number of variables including the amount of use and attention paid to water quality maintenance. You will know it is time for a change when you cannot control sudsing and/or you can no longer get the normal feel or sparkle to the water even though the key water balance measurements are all within the proper parameters.



**CAUTION! READ THIS BEFORE DRAINING:** To prevent damage to the spa's components, turn off power to the spa at the circuit breaker before draining it. Do not turn the power back on until your spa has been refilled. There are certain precautions to keep in mind when draining your spa. If it is extremely cold, and the spa is outdoors, freezing could occur in the lines or the equipment (see "Winterizing", Section 11.7 page 39). On the other hand, if it is hot outdoors, do not leave the spa's surface exposed to direct sunlight for long periods.



**Draining Procedures:**

1. Turn off power to spa at breaker.
2. Locate and remove the front synthetic cabinet door (page 41). The door is located directly below the control panel.
3. Locate drain hose line attached to the 2 x 4 wood slat, Figure A.
4. Pull drain hose from equipment area, Figure B.
5. Hold drain hose above water line, then unthread drain cap (1) from hose using a counterclockwise rotation. Place hose on ground making sure to direct water away from spa.
6. After spa has completely drained, reinstall drain cap on drain valve finger tight! **DO NOT OVERTIGHTEN!**
7. Place drain hose back inside the spa equipment bay.
8. Reinstall synthetic cabinet door.
9. After refilling spa, turn on power and follow the "Spa Fill Up Procedure" (page 17).



Figure A



Figure B

**11.3 Pillow Care**

Remove and clean the headrest pillows as needed with soapy water using a cloth or soft-bristle brush. Always remove the pillows when adding chemical shock treatment to the spa water. The pillows can be returned to the spa when the sanitizer reading is stable as recommended on the inside cover of the manual.



**Pillow Removal/Cleaning Procedure**



Place both hands on pillow with thumbs as shown.

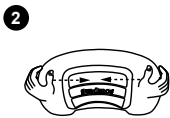

Press inward with thumbs to curl pillow lip inward so you can grab it with fingertips.



Flex pillow lip inward 2-3" to get a good grip on the ends.

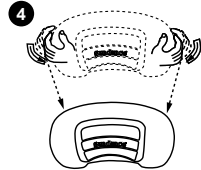

Gently pull outward on pillow to release mounting stud from receptacle on spa shell.

**5** Wash pillow(s) in a mild detergent soap and warm water solution. Never machine wash your pillows or attempt to clean them with a non-approved vinyl cleaning agent!

**6** To reinstall pillows: Simply align pillow over mounting stud receptacle, then gently push inward to snap in place.

## **780 SERIES**

### **11.4 Cleaning The Spa Interior**

To preserve the sheen of your spa's surface, it is crucial that you avoid using abrasive cleaners or cleaners which have adverse chemical effect on the surface. If you are not certain as to the suitability of a particular cleanser, consult your authorized Sundance dealer. Regardless of the cleanser used, use extreme care to assure that no soap residue is left on the surface. This could cause severe sudsing when the spa is refilled.

### **11.5 Vinyl Cover Care And Maintenance**

Using the Sundance insulating spa cover anytime the spa is not in use will significantly reduce your operating costs, heat-up time and maintenance requirements. To prolong the life of the cover, handle it with care and clean it regularly. Below are the care instructions.

#### **A. To Clean and Condition the Vinyl Cover**

1. Use a garden hose to loosen debris and dirt.
2. Using a large sponge or a soft bristle brush, use diluted or mild soap and scrub the vinyl top. Rinse clean and do not allow soap to dry on cover. Do not use soap on the underside of the cover.
3. Please check with your Sundance Spa Dealer for recommended cover care and conditioning products. Condition using non-petroleum based conditioners to keep the vinyl supple and threads/stitching from drying out. Do not use solvents, abrasive cleaners or strong detergents. Do not use products that contain silicone or alcohol.

#### **B. Additional Care and Maintenance Instructions:**

1. Debris can accumulate on the spa cover. Removal of snow or other debris will help to avoid breakage of the foam cores.
2. Be sure to lock the cover straps to secure the cover from unwanted or accidental entry.
3. Do not place heavy objects on the vinyl.
4. Do not walk, sit or stand on the cover.
5. Do not drag or use the flaps/skirt or the cover lock straps to remove the cover.
6. Use only recommended cover lift systems.
7. Use only chemicals and cleaners recommended by Sundance Spas.
8. Remember to keep spa covered when not in use. Maintaining proper water levels assures efficient operation and efficient electrical usage.
9. Do not expose your spa to the sun for extended periods of time as UV rays can damage the interior surface.
10. Use caution when removing cover. Before removing cover, assure all locks have been released to avoid lock breakage and or cover strap damage.

### **11.6 Maintaining The Synthetic Cabinet**

Your new spa's synthetic cabinet requires little or no maintenance of any kind. To clean, simply wipe cabinet with a clean towel and mild soap solution.



**CAUTION:** Never spray cabinet with a garden hose for any reason since this action may induce an electrical short in the spa's electrical equipment.

### 11.7 Winterizing

Your Sundance spa is designed to automatically protect itself against freezing when operating properly. During periods of severe freezing temperatures, you should check periodically to be certain that the electrical supply to the spa has not been interrupted. In extreme, bitter cold weather less than 32°F (0°C), choose the F3 “Standard” filtration/heating mode and program the circulation pump to run for 24 hours to prevent freezing (pages 30 and 31).



If you do not intend to use your spa, or if there is a prolonged power outage during periods of severe freezing temperatures, **it is important that all water be removed from the spa and equipment to protect against damage from freezing.**

Expert winterization of your spa is highly recommended, contact your authorized Sundance dealer. In emergency situations, damage can be minimized by taking the following steps:

#### **CAUTION: TURN OFF POWER TO HOT TUB!**

1. Follow the directions on pages 36-37 for draining the spa.
2. Turn the massage/diverter selector(s) into the middle combo position to allow the water in the plumbing lines to drain (page 26).
3. Turn the waterfall valve(s) to the open position to allow the water in the plumbing lines to drain (page 28).
4. As the water level drops below the seats, use whatever means necessary to get the water out of the recessed seating areas and into the footwell, such as a wet/dry vacuum.
5. Open all the air controls and leave them open until you resume use of the spa, page 26.
6. When the water level ceases to drop, use whatever means available to remove any remaining water from the footwell, such as a wet/dry vacuum.
7. Remove the equipment-side cabinet panels and locate the drain plugs in the front of the pump(s) (Figure A, page 16). Remove these plugs to allow the water to drain out of the pumps and heater.

**Note:** Approximately one to two gallons will be released during this procedure. Use a wet/dry vacuum or other means to keep this from flooding the equipment compartment. Replace the drain plugs.

8. Loosen the hose clamp on the circulation pump intake behind the control box (Figure A, page 16) and pull the hose off (twist hose back and forth while pulling outward). Tip hose down and allow to drain, then reinstall hose and clamp.
9. Loosen hose clamp at bottom of CLEARARRAY® system and pull hose off of CLEARARRAY fitting (twist the hose back and forth while pulling downward). Tip hose down and allow to drain, then reinstall hose

## 780 SERIES

and clamp. Remove the cover of the CLEARRAY system to access the UV bulb and quartz tube. Remove and store the UV bulb in a safe location. Remove and dry off the quartz tube then reinstall it. Depending on the length of time, consider replacing the UV bulb when you resume use of your hot tub.

10. Re-install cabinet side panels and cover spa so that no casual moisture can enter into it.

Consult your authorized Sundance dealer if you have any questions regarding winter use or winterizing.

### 11.8 Restarting Your Spa in Cold Weather

If you want to start up your spa after it has sat empty for a time in freezing temperatures, be aware that the water remaining in certain sections of the piping may still be frozen. This situation will block water flow preventing the spa from operating properly and possibly damaging the equipment. We recommend you consult your dealer for guidance before attempting to re-start your spa under these conditions.

### 11.9 Replacing the Screws on the EZ Access Door

The spa is shipped with phillips screws that secure the door during shipping. The phillips screws could be used if you prefer to use a tool when accessing the equipment bay. Included, in the warranty pack are thumb screws (Figure A) that can be used to replace the phillips screws and provide a tool-free access to the equipment bay. To replace the phillips screws with the thumb screws follow the steps below (Figure B):

1. Remove the phillips screws, one at a time, counterclockwise using a phillips screwdriver.
2. As you remove one phillips screw replace it with a thumb screw. Simply turn the thumb screw clockwise and hand tighten.

#### Note:

- Place the phillips screws in a safe location in case you need to use them at a later time.
- To avoid any injuries, more than one individual must perform the step above.



Figure A

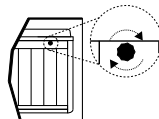
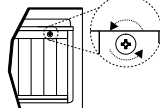

Figure B

### 11.10 EZ Access Door

The spa is shipped with phillips screws that secure the door during shipping. The phillips screws could be used if you prefer to use a tool when accessing the equipment bay. The EZ Access Door provides quick access to the equipment bay and components without having to unscrew the panel. To remove the access door, follow the steps below:

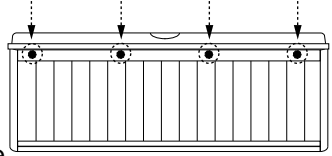

Figure A

1. Locate the EZ Access Door locking bolts on the top of the front panel, Figure A.
2. Turn the locking bolts counterclockwise to unlocked. This will release the panel from the spa frame, Figure B.
3. Slowly and gently tilt the panel forward to remove. This will expose the equipment bay for easy access to the components. Place the panel in a safe location to prevent from damaging it.

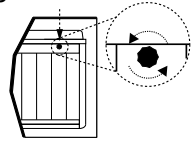

Figure B

**Note:** To avoid any injuries, more than one individual must perform the step above.

4. To reinstall the panel just follow the steps above in reverse order.

### 11.11 Stainless Steel Maintenance

Parts in your Sundance hot tub are manufactured from a high quality 316 stainless steel alloy. Many people are familiar with the term “stainless steel” and are surprised to learn that it does indeed rust and corrode in the presence of chloride salts, free chlorine, or sulfide gasses. The bad news is the environments that produce these elements are ocean spray, salted highways, chemical treatments added to swimming pools and hot tubs, and ground water in numerous coastal areas. The good news is with proper care, your hot tub’s handrails can maintain their original finish.

If your stainless handrails shows signs of rusting you should:

- Wash with fresh water (a good detergent won’t hurt).
- Clean with a good car chrome polish.
- Wax with an automotive or fiberglass wax.

You should never:

- Clean with chlorinated cleaners or scouring powders.
- Use sand paper, “Scotch Brite,” Brillo pads, or similar abrasive products.
- Clean with muriatic or hydrochloric acids. Vinegar is ok, but it won’t do much to remove rust.

## 780 SERIES

### 12.0 Water Quality Maintenance

To decrease the risk of contracting a waterborne illness (e.g. an infection, bacteria or virus) and/or respiratory ailments, maintain water quality within specified limits. This will enhance your enjoyment and prolong the life of the hot tub's equipment. Doing so requires regular attention because the water chemistry involved is a balance of several factors. Procrastination in regard to water maintenance will result in poor and potentially unhealthful conditions for soaking and even damage to your hot tub investment. For specific guidance on maintaining water quality, consult your Authorized Sundance Spas dealer who can recommend appropriate chemical products for sanitizing and maintaining your hot tub.



**WARNING: FAILURE TO MAINTAIN WATER QUALITY WILL:**

- Increase risk of contracting a waterborne illness (e.g. an infection bacteria or virus) and/or respiratory ailments.
- Damage the equipment, components and spa shell, which are not covered under the hot tub's warranty.

**CAUTION:** Never store hot tub chemicals inside the hot tub's equipment bay. The equipment bay may reach elevated temperatures, this is where high voltage electronic devices are located. This area is not intended for storage of any kind.

### 12.1 pH Control

pH is a measure of relative acidity or alkalinity of water and is measured on a scale of 0 to 14. The midpoint of 7 is said to be neutral, above which is alkaline and below which is acidic. In spa water, it is very important to maintain a slightly alkaline condition of 7.4 to 7.6 pH. Problems become proportionately severe the further outside of this range the water gets. A low pH will be corrosive to metals in the spa equipment. A high pH will cause minerals to deposit on the interior surface (scaling). In addition, the ability of the sanitation agents to keep the spa clean is severely affected as the pH moves beyond the ideal range. That is why almost all spa water test kits contain a measure for pH as well as sanitizer.

### 12.2 Sanitizing

To destroy bacteria and organic compounds in the spa water, a sanitizer must be used regularly. Chlorine and bromine are the two most popular sanitizers used to date. SunPurity™ mineral cartridge designed specifically for your hot tub. Many other additives are available for your spa. Some are necessary to compensate for out-of-balance water; some aid in cosmetic water treatment and others simply alter the feel or smell of the water. Your authorized Sundance dealer can advise you on the use of these additives. When adding spa shock (chlorine or non-

chlorine) or pH balancing chemicals activate the jets pump(s) and leave the spa cover open for a minimum of 20 minutes. By doing this you will allow excessive chemical vapors to exit the spa, protecting pillows and plastic knobs from chemical attack.



**WARNING: RISK OF PERSONAL INJURY, DROWNING OR ENTRAPMENT!**

Never leave your hot tub unattended for any reason while the cover is open and accessible, especially to small children and animals!

**CAUTION: RISK OF PERSONAL INJURY OR SPA DAMAGE!**

Never add chlorine tablets (trichlor) or acid to your hot tub for any reason! These chemicals may damage components within your hot tub, burn or irritate your skin, create a rash, and void the manufacturer warranty for your spa.

### 12.3 CLEARARRAY® Water Purification System

Your new hot tub has our water purification system factory installed that will begin disinfecting your water instantly. CLEARARRAY Water Purification System is exclusive technology utilizing natural ultraviolet technology to sanitize your water, disinfecting bacteria, viruses, and algae in portable hot tubs. The ultraviolet light otherwise known as UV-C or germicidal light inactivates the microorganisms by disrupting the DNA so that it cannot reproduce and is considered lifeless. The ballast is the power supply for the purification system; it has two LED indicator lights the green indicating incoming power flow and the red indicating the system is properly working. CLEARARRAY is standard for all models.

**Note:** The CLEARARRAY System only runs when the circulation pump is running and shuts off when either jets pump is manually activated during spa use. The system will remain off for 5 minutes after both jets pumps time out or are manually turned off, then resume operations if the circulation pump is programmed to run.

After a year the bulb must be replaced. If the UV timer has been programmed correctly a message will appear on the LED display when the time allotted has expired. In order to clear the "blb" message a new UV bulb needs to be installed and the timer must be reset (Section 10.6, page 33).

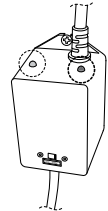

## 780 SERIES

### 12.4 CLEARRAY® Bulb Replacement and Quartz Tube Maintenance

**Important:** It is **MANDATORY** that the UV bulb is replaced and the quartz tube be cleaned every 12 months to maintain optimum performance.

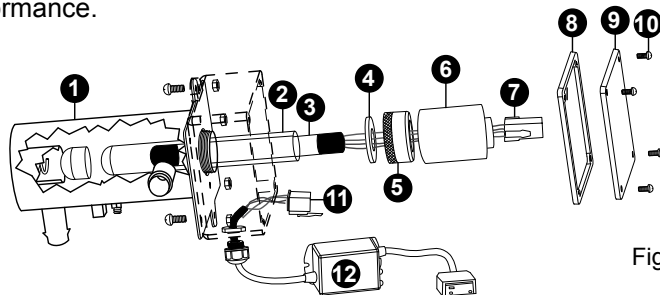

Figure 1



**DANGER:** TURN THE SPA BREAKER TO THE OFF POSITION!



**WARNING:** DRAIN THE SPA IF YOU ARE REPLACING OR CLEANING THE QUARTZ TUBE!



**WARNING:** ALLOW BULB TO COOL DOWN PRIOR TO REMOVING FROM QUARTZ TUBE.



**DANGER:** NEVER LOOK AT THE LIT BULB. THIS CAN CAUSE SEVERE EYE DAMAGE OR BLINDNESS.

#### UV bulb replacement and quartz tube maintenance:

**Note:** Location of CLEARRAY System and connection may vary by model.

1. Turn the breaker to the spa OFF. DRAIN YOUR SPA.

**Note:** If you are only replacing the UV bulb then the spa does not have to be drained. You will need to drain it if you are replacing or cleaning the quartz tube.



**DANGER:** NEVER REMOVE COVER WITHOUT FIRST TURNING OFF AT POWER SOURCE AND DRAINING YOUR SPA.

2. Once the UV bulb has cooled off remove the CLEARRAY System enclosure cover (9) and gasket (8) by removing the four screws (10). This will expose the UV bulb and connections, Figure 2.

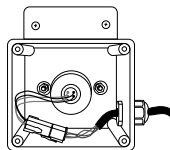
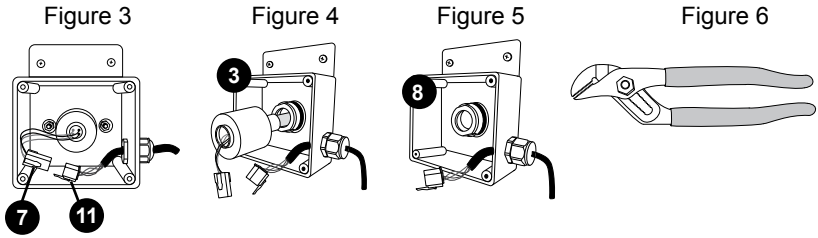

Figure 2





3. Disconnect UV bulb socket (7) from the power cord socket (11), Figure 3.

4. Slowly remove the UV bulb (3) out of the quartz tube, Figure 4.

5. Remove the quartz seal compression nut (5) by turning it **counterclockwise**, Figure 5. Use a pair of channel-lock pliers if needed, Figure 6. You will notice that there is a stainless steel compression washer (4) which slides over the quartz tube, save the washer (4) for later use, Figure 7.

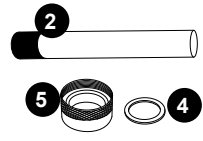

Figure 7

6. Now you are ready to clean or replace the quartz tube (2).

For cleaning the quartz tube (2), follow steps 7 and 8 then proceed from step 9. For replacing quartz tube (2), skip steps 7 and 8 and proceed from step 9.

7. **Cleaning quartz tube:** Clean the quartz tube by wiping, until clear, using a paper towel or a dry cotton cloth. If needed, a household tub and shower lime removal product can be used.



**WARNING:** Do not use abrasive cleaners as they can scratch the quartz tube surface.

8. Rinse the quartz tube with clean water to completely remove any cleaning products that were used in step 7.

9. **Replacing quartz tube:** You will notice that the new quartz tube does not have a black cushion on the domed end as the old quartz tube does. This is normal as the cushion was provided with the original quartz tube to protect it from breakage during transportation. Place the new quartz tube (2) into the water chamber (1) with the domed end first making sure it is inserted and seated inside the quartz end holder. Only a small portion will be exposed when it is seated correctly.

10. Reinstall the compression washer (4) over the open end of the quartz tube (2).

11. Reinstall and hand tighten the quartz seal compression nut (5) by turning it **clockwise**.

12. Refill your spa.

13. **System Test 1:** Assure there is no water dripping from the seal compression nut (5). If water is visible, STOP and tighten the compression nut (5) using a pair of channel lock pliers to a maximum of 1/4 turn. If that does not fix the leak, then repeat quartz tube maintenance process from step 1 through step 12. Make sure there is no water leaking before proceeding to step 14.

## 780 SERIES

- System Test 2:** Reconnect the CLEARRAY unit to the controller. Turn breaker back ON. Turn on the pump to circulate the water through the CLEARRAY System. Wait for 5 minutes and assure no water is dripping. If water is visible, STOP, fix the leak by repeating quartz tube maintenance process from step 1 through step 13. **Make sure there is no water visible. Turn the pump and breaker OFF BEFORE proceeding to step 15.**
- Reconnect the UV bulb socket (7) to the power cord socket (11) make sure you use the latex glove provided when handling the UV bulb.



**WARNING:** DO NOT TOUCH THE NEW UV BULB WITH YOUR BARE HAND. Oil on your skin will cause hot spot on the UV bulb and shorten the life of your UV bulb. Use the provided latex glove to handle the UV bulb.

- Slide the new UV bulb (3) back inside the quartz tube.
- Reinstall the black bulb boot (6) back over the quartz seal compression nut (5).
- Reinstall the enclosure cover (9) with gasket (8) and secure with the screws.
- Properly dispose of the old UV bulb.



**WARNING:** This CLEARRAY System includes a UV bulb, which contains mercury. Dispose of the bulb in accordance with disposal laws. See [www.lamprecycle.org](http://www.lamprecycle.org).

- Once power is activated you can check the ballast (12), Figure 8, to see if the CLEARRAY System is functioning. A solid green light indicates that the CLEARRAY System is being provided power and should always be on. A solid red light indicates that UV bulb is activated.

Indicator  
Lights

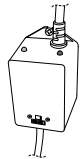

Figure 8

## 13.0 Error Conditions/Error Messages

There are a number of unique functions designed into your spa to protect it from damage and/or aid in troubleshooting. Refer to Sections 13.1-13.9 below for a listing of all possible error messages and their meanings.

**Always insist on genuine Sundance replacement parts.**

### 13.1 Summer Logic

When the actual spa water temperature reaches up to 2°F (1°C) above the set temperature, the spa goes into “summer logic.” The circulation pump will turn off automatically to avoid adding additional heat to the water, eventually creating an overheat condition. This setting is not user-programmable.



**Note:** The summer logic does not take effect until the spa water temperature reaches 95°F (35°C). This condition is more likely in excessively hot weather. Remember, the spa’s ability to cool is directly affected by the ambient temperature. An excessively hot ambient temperature may prevent the spa from cooling down because it’s fully insulated construction is designed to retain heat and to minimize operating costs.

### 13.2 Overheat Condition



**WARNING: RISK OF HYPERTHERMIA (OVER-HEATING)  
CAUSING SEVERE INJURY, BURNS, OR WELTS.**

**DO NOT ENTER SPA WATER!** Water is too hot. Overheat protection. Heater is deactivated. Spa water temperature is above acceptable limits. When the actual water temperature is approximately 2°F (1°C) above the set temperature, the circulation pump will stop operating to reduce (frictional) heating. To correct condition, remove spa cover to speed cooling. **(CAUTION! Never leave spa uncovered when children are present!)** If condition persists, contact your authorized Sundance dealer.



### 13.3 Panel displays SN1

Open sensor (heater is disabled) or shorted sensor (spa is deactivated). The high-limit temperature sensor is not functioning. Your authorized dealer must repair this.



### 13.4 Panel displays SN2

Open or shorted sensor (heater disabled). The temperature sensor is not functioning. Your authorized dealer must repair this.



## 780 SERIES

### 13.5 Panel displays FL1 or FL2

A flashing “FL1” display means the flow switch is malfunctioning open, the circulation pump’s filter cartridge is excessively dirty, or an “air lock” condition has occurred at the circulation pump intake. A flashing “FL2” display means the flow switch is malfunctioning closed.

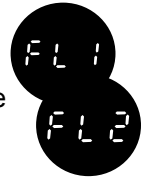

- This error will cause the heater to deactivate. The main pump #1 may also deactivate.
- This problem is caused by an interruption in water flow from an excessively dirty filter cartridge, an “air lock” condition at the pump intake, or by a malfunctioning flow switch.

To Correct Condition:

1. Turn the breaker OFF!
2. Verify water level is above all jets and below lowest pillow. Add water if necessary.
3. Check for clogged/excessively dirty filter cartridge. See Section 11.1 (pages 34-35).
4. Purge “air lock” from circulation pump intake by removing the filter cartridge. Hold your garden hose over the filter wall fitting (with grate) using a rag as a seal around hose end, then ask a helper to turn on water for 30 seconds, then turn off. Reinstall filter cartridge and check spa. Section 11.1 (pages 34-35).
5. If the circulation pump is not running, turn power off at the main breaker, then turn power back on.
6. If problem persists, contact your authorized dealer.



### 13.6 Panel displays COL

Cool Condition - Temperature has dropped 20°F (11°C) below the current set temperature. The pump and heater have been activated to bring the temperature to within 15°F (8°C) of the set temperature. No corrective action is required.



**Note:** During cold periods, you may consider increasing the number of filtration cycles.

### 13.7 Panel displays ICE

Freeze Protection - A potential freeze condition has been detected. No action is required. Main pump will operate to circulate warm water through the plumbing until the spa is out of danger.



### 13.8 Panel displays - - -



**WARNING: RISK OF HYPERTHERMIA (OVER-HEATING)  
CAUSING SEVERE INJURY, BURNS, OR WELTS.**

**DO NOT ENTER SPA WATER!** The safety “Watchdog” software has been triggered and the spa is deactivated. A problem has been detected which could cause damage to the spa or its components. Contact your authorized dealer.

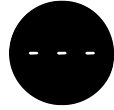

### 13.9 Panel displays blb

UV bulb needs to be replaced. The message will flash between “blb” and the water temperature. The countdown timer for the UV bulb needs to be reset (Section 10.6, page 33). A new UV bulb can be purchased from a local Sundance Spas dealer.



## 14.0 Troubleshooting Procedures

In the event your Sundance spa is not working the way it should, please first review all the installation and operating instructions in this manual and check the message on the panel display. If you are still not satisfied it is working properly, please follow the appropriate troubleshooting instructions.

**Note:** If any of the supply cords to the accessories are damaged, they must be replaced by authorized service personnel.

### 14.1 None of the Components Operate (e.g. Pump, Light)

Check the following:

1. Is there power to the spa?
2. Is the household circuit breaker tripped?
3. Call your authorized dealer.

### 14.2 Pump Does Not Operate but Light Does

Press the JETS 1 Button:

1. If no water movement is detected, make sure power is going to the spa and check the water level. If it does not solve the problem, contact your authorized Sundance dealer.
2. The main pump operates but no water flows to jets. Pump may not be properly primed. This can happen after the spa is drained and refilled. Press the JETS 1 button several times, never leaving the motor on for more than 5 to 10 seconds at a time. Turn power off and let the air out by loosening the cap on the massage selector and/or removing the filter. Refer to Section 8.2 (page 24). Make certain you tighten the massage selector cap and/or reinstall the filter before turning on spa power and restarting the pump.

## **780 SERIES**

### **14.3 Poor Jet Action**

1. Press the JETS 1 button to make certain the pump #1 is on.
2. Rotate the air control clockwise to the "on" position.
3. Check for dirty filter. Clean, if necessary.
4. Make sure jets are all the way open.

### **14.4 Water is Too Hot**

Reduce thermostat setting so the heater turns off.

### **14.5 No Heat**

1. Check thermostat setting.
2. Keep the spa cover in place while heating.
3. Check the settings to see if your spa is in economy filtration/heating mode (pages 29-30).

Should checking the above steps fail to correct the problem, please call your dealer so that they may arrange service. We build the best spas in the industry. Nonetheless, we are always striving to improve the quality and features of our products. Your input as a Sundance spa owner is a cherished part of this process. If you have any comments or suggestions, or if you wish to be informed on any new products for your spa, please write to us.

**CONGRATULATIONS** on your good taste and welcome to the happiest and most relaxed family in the world!

# 15.0 North American Dover Convertible Circuit Diagram

This wiring diagram is used for all North American 120/240 VAC (60 Hz) convertible power models.

**⚠ DANGER**  
RISK OF SHOCK OR ELECTROCUTION!

Turn power off before servicing. This task should only be performed by a qualified technician.

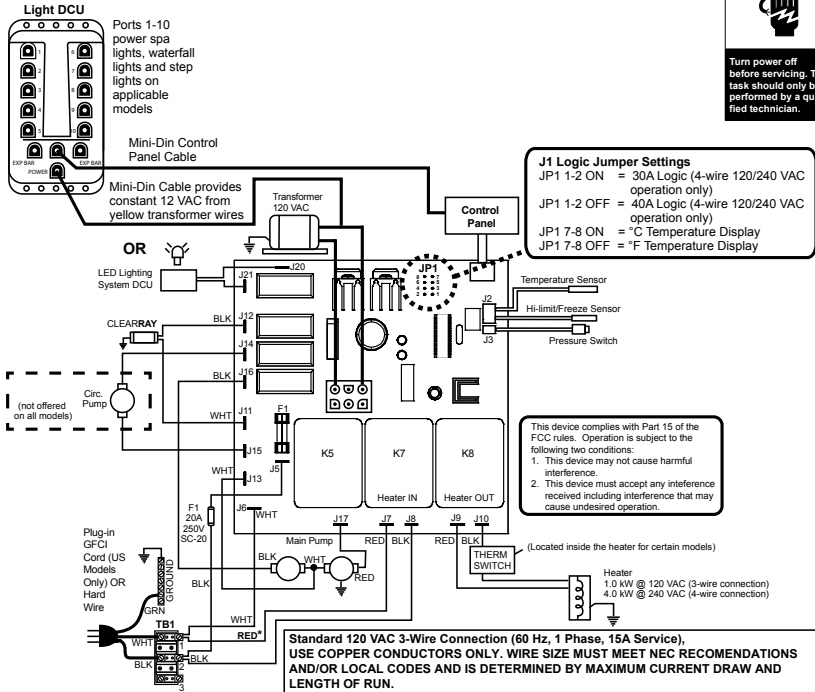

**WARNING, ELECTRICAL SHOCK HAZARD EXISTS!** Always remove power to spa before wiring and/or configuring the circuit board

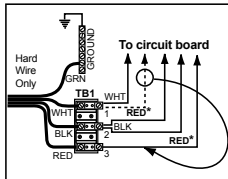

**Optional 4-Wire 240/120 VAC Convertible Heater Connection**

1. Remove and discard the factory installed GFCI Cord.
2. Move RED\* wire from TB1 position #1 to TB1 position #3 as shown below.
3. Permanently connect to the power supply. Use copper conductors ONLY. Wire size must be appropriate per NEC and/or local codes.
4. If hot tub is to be operated on 30A service, make sure the jumper provided at location JP1 #1 & 2 on the circuit board is installed. If hot tub is to be operated on 40A service, remove the jumper JP1 #1 & 2 on the circuit board.

EXTERNAL SERVICE PANEL BOX DISCONNECT MEANS MUST BE LOCATED NO CLOSER THAN 5 FT. (1.52m) FROM THE INSIDE WALLS OF THE SPA AND WITHIN SIGHT OF SPA

MAIN POWER ON/OFF SHUTOFF SWITCH

# 780 SERIES

## 16.0 North American Certa/Chelsee/Hamilton/Montclair Circuit Diagram

This wiring diagram is used for all North American 240 VAC (60 Hz) dedicated power models.

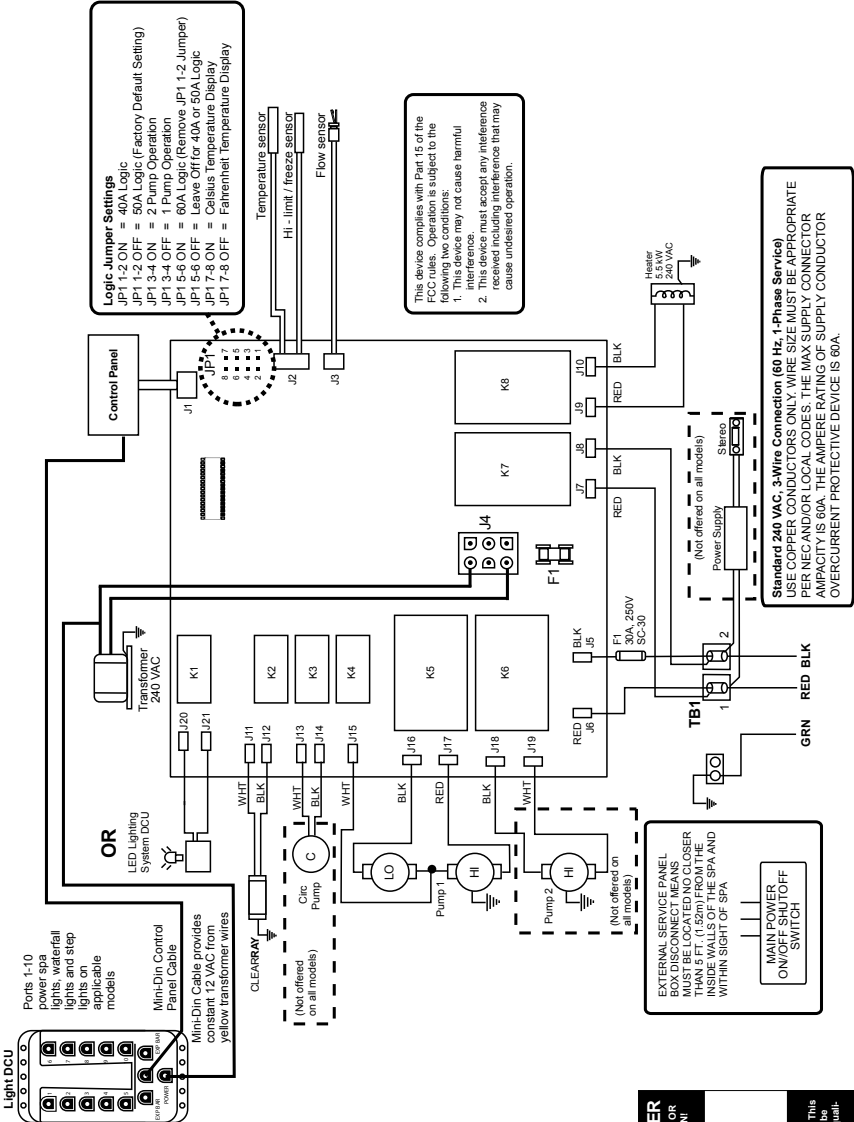

**⚠ DANGER**  
 RISK OF SHOCK OR ELECTROCUTION!

Turn power off before servicing. This task should only be performed by a qualified technician.



# 17.0 Export Dover Circuit Diagram

This wiring diagram is used for Export 230 VAC (50 Hz) dedicated power models.

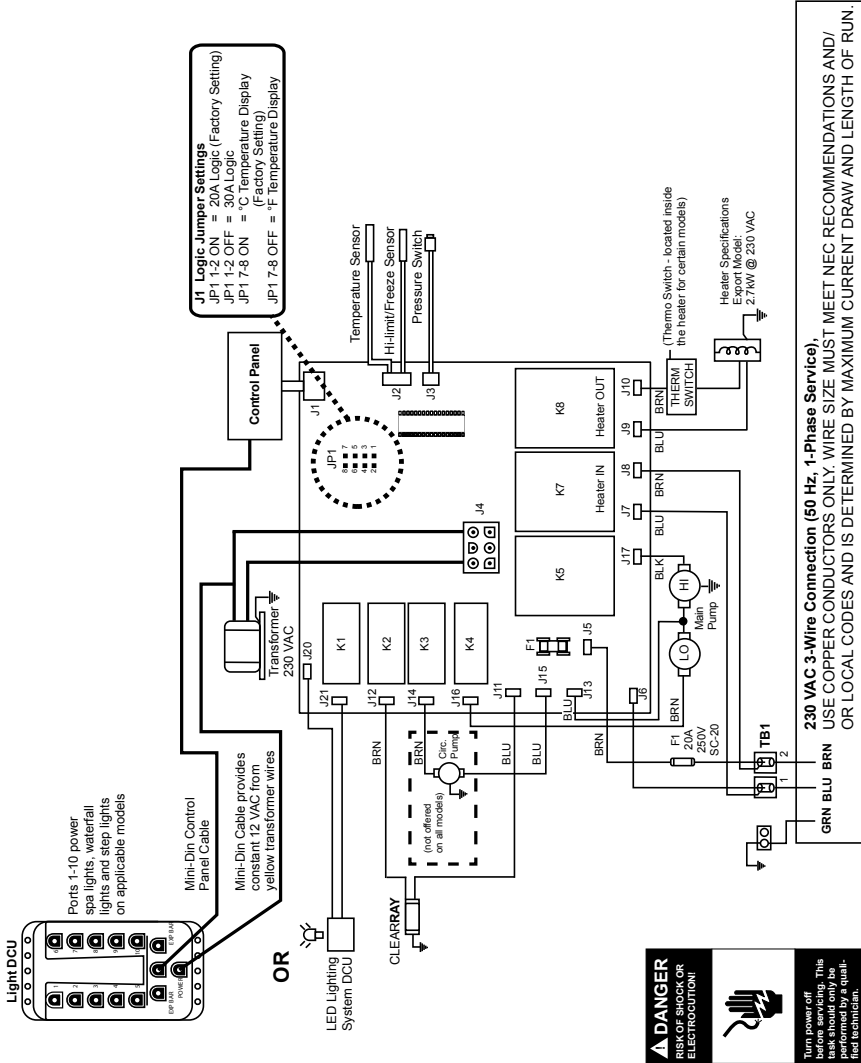

**⚠ DANGER**  
 RISK OF SHOCK OR ELECTROCUTION!

Turn power off before working on this system. This work should only be performed by a qualified technician.

# 780 SERIES

## 18.0 Export Certa/Chelsee/Hamilton/Montclair Circuit Diagram

This wiring diagram is used for Export 230 VAC (50 Hz) dedicated power models.

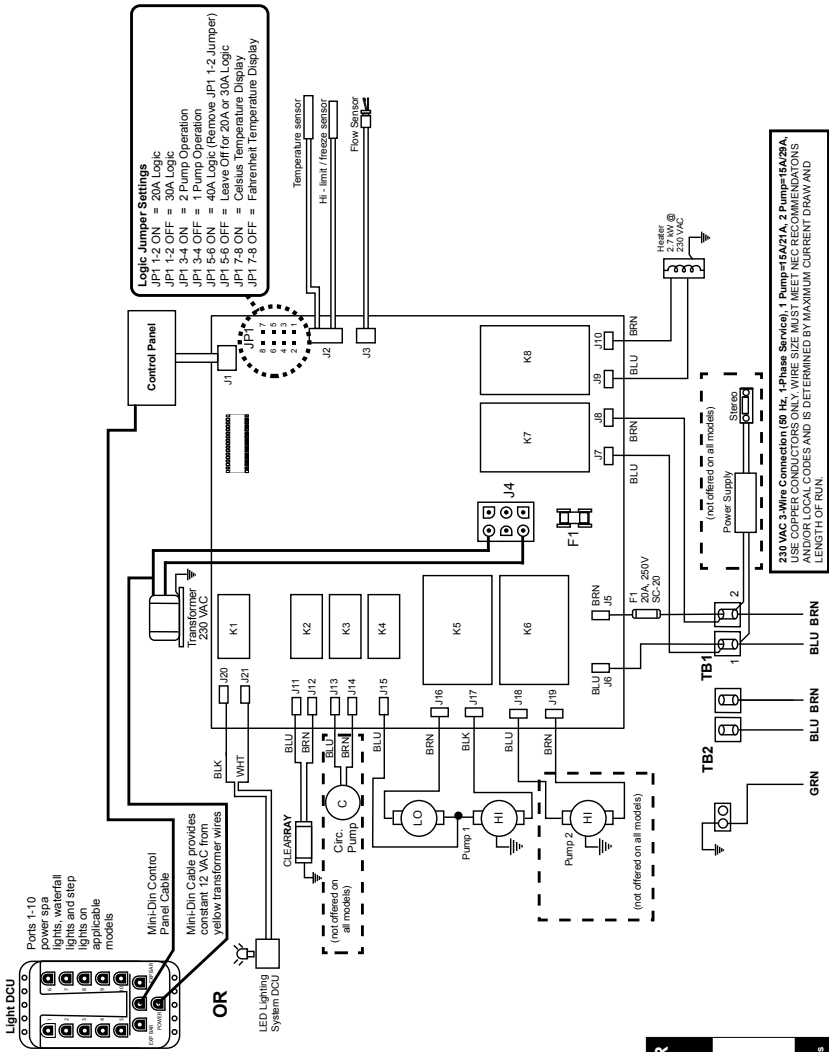

**⚠ DANGER**  
RISK OF SHOCK OR ELECTROCUTION!



Turn power off before servicing. This work must be performed by a qualified technician.

## 19.0 Optional BLUEWAVE® Spa Stereo System

To start enjoying your new stereo receiver, please read the following operation instructions in their entirety.

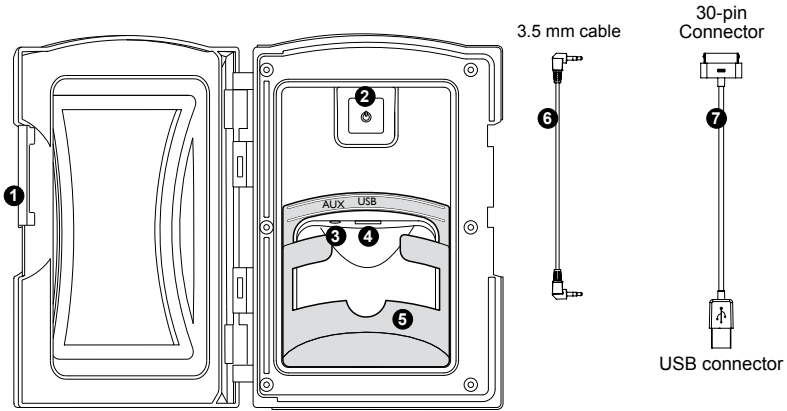

1. **Media Locker Handle**  
Slide the handle to lock and unlock the protective door.
2. **Power Button**  
Press power button once to turn “ON” stereo system. Press a second time to place the stereo in “Standby” mode and the red light will remain illuminated.
3. **Auxiliary Input Jack Connector**  
Allows you to connect an auxiliary device by using a 3.5 mm cable.
4. **Universal Serial Bus (USB) Device Connector**  
Allows you to connect your device via a USB port and a USB cable compatible with your device.
5. **Auxiliary Device Holding Base**  
The removable base securely holds the Auxiliary device, such as an iPod/MP3/iPhone, in place. It can be removed for larger devices.
6. **3.5 mm Cable (purchaed separately)**  
Use this cable to connect your Auxiliary or MP3 device to the stereo via the “AUX” connection.
7. **Apple 30-pin to USB Cable (purchaed separately)**  
Use this cable to connect your compatible iPod, iPhone or MP3 device to the stereo via the “USB” connection.



**WARNING: RISK OF ELECTRICAL SHOCK HAZARD**

**EXISTS AND EQUIPMENT DAMAGE!** Never install or remove electrical devices (e.g. Apple device/MP3/USB/AUX/Bluetooth) while hands are wet or while sitting partially or fully immersed in the spa!

**CAUTION:** Never leave electrical devices in the Media Locker when spa is not in use to prevent damage from outdoor elements! Never spray Media Locker with a pressurized water hose for any reason! Damage to the device or spa stereo system caused by water intrusion is not covered under the manufacturer’s warranty! Damage to Media Locker port or electrical devices due to excessive force or improper alignment during installation or removal from Media Locker is not covered under warranty.

**19.1 Pairing the Remote and Stereo**

In order for the remote to operate the stereo, you need to pair them using the following method:

1. Make sure the stereo unit is in “Standby” mode. LED power light will be red, Figure A.
2. Press any button on the remote to turn it ON. The remote LCD display will read “No Link.”
3. Press and hold the “Mode” button on the remote (Figure B). At the same time, press and hold the power button on the stereo for 2 seconds (Figure A).
4. The remote LCD display will read “Welcome,” “Load” and “Radio” if the pairing sequence was successful.

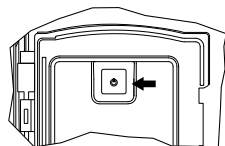

Figure A

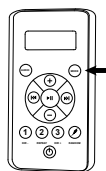

Figure B

**19.2 Audio Settings**

The Audio button, Figure C, provides access to many of the stereo’s settings. By continually pressing the Audio button you can scroll and adjust the following functions: BAS-TRE-BAL-FAD-DSP-AREA-LOUD-DX-STEREO (respectively).

**Note:** You can adjust the settings by pressing the Audio button, making your adjustments and pressing the Audio button to go the next feature. If you exit the setting menus continually press the Audio button until you reach the setting you would like to adjust.

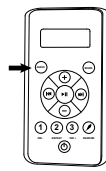

Figure C

1. **Bass Setting:** Press the Audio button once to access the bass setting. The LCD display will change to “BAS 0,” Figure D. Press the Up button to adjust the setting to a maximum of +5. Press the Down button to adjust the setting down to -5.

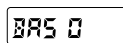

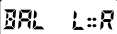

Figure D

**Note:** The default setting is “0.” This feature is disabled when a “Digital Sound Processor” (DSP) setting is active such as “Rock,” “Classic,” or “Pop.”

2. **Treble Setting:** Press the Audio button 2 times to access the treble setting. The LCD display will change to “TRE 0,”  Figure E. Press the Up button to adjust the setting to a maximum of +5. Press the Down button to adjust the setting down to -5.

**Note:** The default setting is “0.” This feature is disabled when a “Digital Sound Processor” (DSP) setting is active such as “Rock,” “Classic,” or “Pop.”

3. **Balance Setting:** Press the Audio button 3 times to access the balance setting. The LCD display will change to “BAL L=R,”  Figure F. Press the Up button to adjust the setting to a maximum of 10R (only the right side speakers will have volume). Press the Down button to adjust the setting down to 10L (only the left side speakers will have volume).

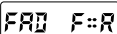
4. **Fade Setting:** Press the Audio button 4 times to access the fade setting. The LCD display will change to “FAD F=R,”  Figure G. Press the Up button to adjust the setting to a maximum of 10F (only the front speakers will have volume). Press the Down button to adjust the setting down to 10R (only the rear speakers will have volume).

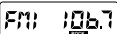
5. **Digital Sound Processor (DSP) Setting:** Press the Audio button 5 times to access the DSP setting. The LCD display will change to “DSP OFF,”  Figure H. Press the Up button to select one of the preset settings such as Rock, Classic or Pop. If a preset setting is selected a small icon will appear on the LCD display,  Figure I.

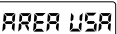
6. **Area Setting:** Press the Audio button 6 times to access the Area setting. The LCD display will change to “AREA USA,”  Figure J. Press the Up button to select either USA or EUR setting.

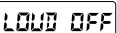
7. **Loud Setting:** Press the Audio button 7 times to access the Loud setting. The LCD display will change to “LOUD OFF,”  Figure K. Press the Up button to select either OFF or ON.

8. **Distant Setting:** Press the Audio button 8 times to access the Distant setting. The LCD display will change to “DX,”  Figure L. Press the Up button to select either Distant (DX) or Local for station frequency. The “LOCAL” setting allows for better FM reception when a local station is too strong. Leave the setting to “DX” if this condition does not exist.

## 780 SERIES

9. **Stereo Setting:** Press the Audio button 9 times to access the Stereo setting. The LCD display will change to “STEREO,” Figure M. Press the Up button to select either Stereo or Mono.

STEREO

Figure M

### 19.3 Wireless Remote Control Functions

A wireless radio frequency (RF) remote control is supplied on all spas with the optional audio system. This remote provides control of the radio and over some media device functions.

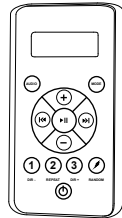



#### A. External Media Device Playback

The supplied remote control provides no control over external Auxiliary player operations except for volume control and source selection. The Auxiliary player performs all external playback operations.

Button	Operation
	Power Button: Press once to turn remote “ON” (remote LCD display will read “No Link.”); Press second time to turn stereo “ON” (remote LCD display will read “Welcome”); Press a third time to place the stereo in “Standby” mode.
	Audio Button: Allows access to most of the stereo sound functions. Press continuously to scroll through the following settings (if applicable): Bas-Tre-Bal-Fad-DSP-Area-Loud-DX-Stereo.
	Mode Button: Press continuously to switch between “RADIO,” “USB,” and “AUX IN” modes. “BT AUDIO” appears when a Bluetooth device is paired with the stereo.
	Volume Up Button: Used to increase volume between 0 to 30.
	Volume Down Button: Used to decrease volume between 30 to 0.

Button	Operation	
	Device Mode (USB)	Radio Mode
	Play/Pause Button: Press to pause track, press again to resume playing	Mute Button: Press to mute sound, press again to reactivate sound
	Track Down Button: Press to rewind tracks.	Seek Down Button: Seeks down for stations.
	Track Up Button: Press to move forward tracks.	Seek Forward Button: Seeks forward for stations.
	Press the button to change music folders.	Preset 1: Press to access a preset station.

 REPEAT	Apple Device: Press once to repeat song. Press again to repeat entire album. Press again to turn off. USB Mode: Press once to turn on. Press again to turn off.	Preset 2: Press to access a preset station.
 DIR +	Press the button to change music folders.	Preset 3: Press to access a preset station.
 RANDOM	Press to play songs in a random order.	Not used

## 19.4 Electronic Device Connections and Functions

### IMPORTANT REMOTE NOTICE:

- If stereo unit is “ON” (blue light is illuminated on the stereo power button) then press the power button on the remote once.
- If stereo unit is in “Standby” (red light is illuminated on the stereo power button) then press the power button on the remote once to activate the remote (remote LCD display will read “NO LINK”). Press the button again to activate the stereo unit (remote LCD display will read “WELCOME”).

### A. Operating the Radio:

1. Turn power “ON” to the stereo unit. Press the power button on the remote.
2. The LCD screen on the remote will display the following: “Welcome,” “Load,” “Radio” and the station number, Figure A.
3. You can use the seek button to search for frequencies.
4. You can save up to 3 stations as presets. Follow the steps below to set a station:
  - a. Find a station you want to save.
  - b. Press and hold one of the three preset buttons. The station preset number (1, 2, or 3) on the display will quickly flash to confirm the setting. To set the additional two stations, conduct this step again.

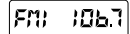

Figure A

## 780 SERIES

### B. Connecting Your Apple device/MP3 Player Using the USB:

1. Locate the USB port in the stereo locker (Figure B).
2. Use a 30-pin cable (purchased separately) for compatible devices (Figure C) or a cable provided with your device.
3. Connect the USB end of the cable into the USB connection on stereo.
4. Connect the 30-pin end of the cable to the Apple device/MP3 Player (purchased separately), Figure D.
5. After connecting the cable to both devices, set the player into the rubber holding base, Figure E.

**Note:** This also charges most compatible Apple devices when connected.

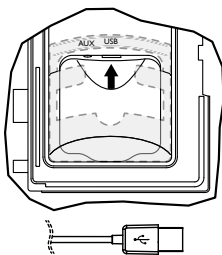

Figure B

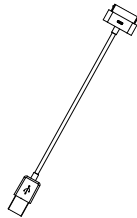

Figure C  
(purchased separately)

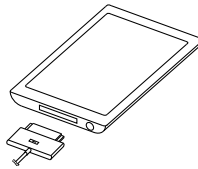

Figure D  
(device purchased separately)

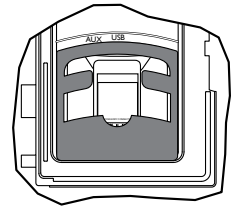

Figure E



### **CAUTION: RISK OF ELECTRICAL SHOCK OR EQUIPMENT DAMAGE!**

Never install, remove or operate any electrical device (e.g. Apple device/MP3/USB/AUX/Bluetooth) while hands are wet or while sitting partially or fully immersed in the spa!

**Note:** The DRM (Digital Rights Management) Files cannot be played on this deck. Personal files (MP3, WMA, iTunes or AAC) can be played as long as they are not DRM encrypted.

### C. Operating USB/MP3/Apple device

1. Turn power "ON" to the stereo unit. Turn power "ON" to the remote.
2. The LCD screen on the remote will display the following: "Welcome," "USB," "Load," "Apple" (final display will vary depending on the device connected). All functions are performed through the remote.
3. While the music is playing the remote screen will display and continually scroll through the following: Artist, Album, Song and Track information.
4. For operational functions refer to the "External Media Device Playback" section.



**D. Operating the USB drive:**

1. Plug in your USB device into the “USB” connection on the stereo, Figure A.
2. Turn power ON to the stereo unit and the stereo remote.
3. The LCD screen on the remote will display the following: “Welcome,” “USB,” “Load,” “TOL XX” (final display will vary depending on the whether the USB holds folders or files). All functions are performed through the remote.
4. While the music is playing the remote screen will display and continually scroll through the following: Title, Song, Artist, Album, Dir, Music and Track information.
5. For operational functions refer to the “External Media Device Playback” section.

**E. Connecting Your Auxiliary Player Using the 3.5 mm Cable:**

1. Plug one end of the cable to “Aux” connection on the stereo, Figure F.
2. Plug the other end of the cable into the headphone jack connection on the iPod/MP3 Player.
3. Press the Mode button on the remote to “AUX IN.”
4. All playback operations are conducted via the Auxiliary Player. The stereo remote functions do not work on the external Auxiliary Player (except volume control).

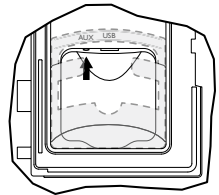

Figure F

**F. Connecting Your Bluetooth Device:**

1. Turn power ON to the stereo unit.
2. From your Bluetooth device, make sure the Bluetooth setting is ON.
3. Follow the pairing instructions for your Bluetooth device and connect to the “BLUEWAVE” device that appears on your screen.
4. If asked for a password, enter the code “0000.”
5. The remote LCD screen will display, “BT AUDIO” if the process was successful.

**G. Operating Your Bluetooth Device:**

1. Press the seek up or down buttons to scroll through the tracks (on the remote).
2. Press the volume up or down buttons to adjust volume level between 0 to 30 (on the remote).
3. Any other playback operations are conducted via the Bluetooth device.

**CAUTION: RISK OF ELECTRICAL SHOCK OR EQUIPMENT DAMAGE!**

Never install, remove or operate any electrical device (e.g. Apple device/MP3/USB/AUX/Bluetooth) while hands are wet or while sitting partially or fully immersed in the spa!

**780 SERIES**

**19.5 Wireless Remote Battery Replacement Procedure**

- 1. Turn the remote unit over and locate the battery door (Figure A).

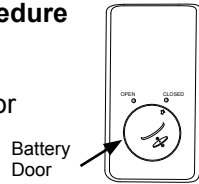

Fig. A

- 2. Rotate the battery door, with a coin, counterclockwise to the Open position (Figure B). When the door is unlocked it will pop up slightly.

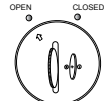

Fig. B

- 3. Remove battery door by lifting the door upward (Figure C).

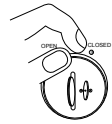

Fig. C

- 4. Replace battery using an equivalent battery (Figure D).

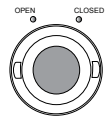

Fig. D

- 5. Reinstall the battery cover, using the coin rotate the door to the Close position (Figure E).

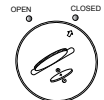

Fig. E

**Note:** Remote unit is water resistant not waterproof. Although it is designed for use while in the spa, it should never be left in the spa while the cover is on and spa is not in use. The remote should be stored in a dry location such as the stereo remote pouch (if applicable) located on the outside of the spa cover or within your home. Extreme weather can affect the remote control battery. In extreme hot or cold environments store the remote control indoors to prolong battery life.

**19.6 BLUEWAVE Spa Stereo System Specifications**



Power supply . . . . . 10.7-14.4V DC

**Tuner**

FM radio sensitivity . . . . . 8uV

FM radio reception . . . . . Stereo

## 19.7 Stereo Cautions

1.  **“CAUTION** - Risk of Electric Shock. Do not leave compartment door open.”
2.  **“CAUTION** - Risk of Electric Shock. Replace components only with identical components.”
3. “Do not operate the audio/video controls while inside in the spa.”
4.  **“WARNING** - Risk of Electrocution. Do not connect any auxiliary components (for example cables, additional speakers, headphones, additional audio/video components, etc.) to the system.”
5. These units are not provided with an outdoor antennae; when provided, it should be installed in accordance with Article 810 of the National Electrical Code, ANSI/NFPA 70.
6. Do not service this product yourself as opening or removing covers may expose you to dangerous voltage or other risk of injury. Refer all servicing to qualified service personnel.
7. When the power supply connections or power supply cord(s) are damaged; if water is entering the audio/video compartment or any electrical equipment compartment area; if the protective shields or barriers are showing signs of deterioration; or if there are signs of other potential damage to the unit, turn off the unit and refer servicing to a qualified service personnel.
8. This unit should be subjected to periodic routine maintenance (for example, once every 3 months) to make sure that the unit is operating properly.



