



680 SERIES

BURLINGTON™ | DENALI™ | HARTFORD™
HAWTHORNE™ | PEYTON™ | TACOMA™

OWNER'S MANUAL

6530-681Y REV. B

Sundance® Spas

Attention New Spa Owner!

Congratulations on the purchase of your new Sundance® 680 Series spa! The following is a list of automated functions and maintenance recommendations for your new spa. Automated functions have been listed below in an attempt to suppress any operational concerns you may have during startup and the first 24 hours of ownership! Maintenance recommendations are listed in an attempt to stress their importance in protecting your new spa.

Automated Operations

Approximately two minutes after power is applied to the spa, the first filtration/heating cycle turns on pump 1. With two pump models, an automatic five minute “blow-out” function also activates pump 2 for a period of five minutes to flush all lines. Then, after five minutes, pump 2 turns off and pump 1 continues to operate for the duration of the cycle.

Note: This function only occurs during the first filtration/heating cycle each day.

Maintain Healthy Spa Water

Always maintain your spa’s water chemistry within the following parameters:

	with CLEARRAY™	without CLEARRAY™
pH	7.4-7.6	7.4-7.6
Free chlorine	no less than 1.0 ppm	0.5-1.0 ppm
Free Bromine	no less than 2.0 ppm	1.0-2.0 ppm
Total Alkalinity	100-120 ppm	100-120 ppm
Calcium Hardness	150-250 ppm	150-250 ppm

IMPORTANT: CLEARRAY™ Water Purification System is factory installed. If the CLEARRAY™ system is altered or is not operating efficiently then follow the “without CLEARRAY™” water chemistry parameters as defined by the Association of Pool and Spa Professionals. CLEARRAY™ requires an annual lamp replacement to properly sanitize your water.

 **TO DECREASE RISK OF INFECTION OR DISEASE!** Always maintain your spa filter as outlined below to ensure healthy spa water. Refer to page 36 for additional information.

Required Filter Maintenance

Your new spa is equipped with an advanced water filtration system that provides unsurpassed water quality! To ensure maximum water quality at all times, you should clean and reuse both filter cartridges every month or as needed. See page 36 for detailed filter cleaning/replacement instructions.

Required Water Maintenance

 **TO DECREASE RISK OF INFECTION OR DISEASE!** You should replace the spa’s water every 3 months. The frequency depends on a number of variables including frequency of use, number of users, and attention paid to water quality maintenance. You will know it is time for a change when you cannot control sudsing and/or you can no longer get the normal feel or sparkle to the water, even though the key water balance measurements are all within the proper parameters. See pages 41-42 for additional information.

Table of Contents

1.0	Important Spa Owner Information	1
2.0	FCC Notice	1
3.0	Important Safety Instructions for all Spa Owners	2
3.1	Entrapment Risk	6
3.2	Hyperthermia	7
3.3	Important CSA Safety Instructions (Canada only)	8
3.4	General Electrical Safety Instructions.....	8
4.0	Choosing A Location	9
4.1	Outdoor Location	10
4.2	Indoor Location.....	11
5.0	Power Requirements	12
5.1	North American 60 Hz Power Options.....	12
5.2	Export 50 Hz Power Options	14
6.0	Electrical Wiring Instructions	15
7.0	Spa Fill Up Procedure	18
8.0	Control Functions	23
8.1	Control Panel.....	23
8.2	General Spa Features And Controls.....	24
8.3	General Spa Features And Controls (Peyton).....	25
9.0	Operating Instructions	26
9.1	Setting Water Temperature.....	26
9.2	Activate Pumps.....	27
9.3	SunGlow™ Light Operation (Denali and Tacoma Models)	27
9.4	Multi-Colored LED Light System Operation (Burlington, Hartford, Hawthorne, and Peyton Models).....	28
9.5	Adjusting Individual Jet Flow	29
9.6	Selecting Desired Massage Action	29
9.7	Air Controls.....	29
9.8	Optional Audio System	29
10.0	Automatic Filtration Cycles	30
10.1	Standard Filtration/Heating Modes For Models <u>Without</u> Circulation Pump Option	30
10.2	Standard Filtration/Heating Modes For Models <u>With</u> Circulation Pump Option	30

10.3	Economy Filtration/Heating Modes (F4-F6).....	30
10.4	Lock Modes (L1-L2).....	30
10.5	Selecting The Filtration/Heating Mode	31
10.6	Filtration Modes for Spas <u>Without</u> Circulation Pump Option	31
10.7	Filtration Modes for Spas <u>With</u> Circulation Pump Option	32
10.8	Programming the Circulation Pump Filtration Cycle (For Spas Equipped with a Circulation Pump).....	33
10.9	Programming the CLEARRAY (Ultraviolet) Water Purification System.....	34
11.0	Spa Maintenance.....	36
11.1	Cleaning The Filter	36
11.2	Draining and Refilling	37
11.3	Pillow Care (All Models Except Denali)	38
11.4	Cleaning The Spa Interior.....	38
11.5	Maintaining The Cover	39
11.6	Maintaining The Synthetic Cabinet.....	39
11.7	Winterizing.....	40
11.8	Restarting Your Spa in Cold Weather	41
12.0	Water Quality Maintenance	41
12.1	pH Control	41
12.2	Sanitizing	42
12.3	CLEARRAY™ Water Purification System	42
12.4	CLEARRAY™ Lamp Replacement and Quartz Tube Maintenance.....	43
13.0	Error Conditions/Error Messages	46
13.1	Summer Logic (Spas <u>With</u> Circulation Pump Option).....	46
13.2	Panel Displays SN1	46
13.3	Panel Displays SN2.....	46
13.4	Panel Flashes FL1 or FL2 (Spas <u>Without</u> Circulation Pump Option)	46
13.5	Panel Flashes FL1 or FL2 (Spas <u>With</u> Circulation Pump Option)	47
13.6	Panel Displays COL.....	47
13.7	Panel Displays ICE.....	47
13.8	Panel Displays OH	47
13.9	Panel Displays - - -	48
13.10	Panel Displays BLB.....	48

14.0	Troubleshooting Procedures	48
14.1	None of the Components Operate (e.g. Pump, Light).....	48
14.2	Pump Does Not Operate but Light Does.....	48
14.3	Poor Jet Action.....	49
14.4	Water is Too Hot.....	49
14.5	No Heat.....	49
15.0	North American Denali/Tacoma Convertible	
	Circuit Diagram (60 Hz)	50
16.0	North American Burlington Circuit Diagram (60 Hz)	51
17.0	North American Peyton Circuit Diagram (60 Hz)	52
18.0	North American Hartford and Hawthorne Models	
	(60 Hz)	53
19.0	Export Denali/Tacoma Circuit Diagram (50 Hz)	54
20.0	Export Burlington Circuit Diagram (50 Hz)	55
21.0	Export Peyton Circuit Diagram (50 Hz)	56
22.0	Export Hartford and Hawthorne Circuit Diagram	
	(50 Hz)	57

1.0 Important Spa Owner Information

Your Sundance® 680 Series spa is constructed to the highest standards and is capable of providing many years of trouble-free use. However, because heat retentive materials are utilized to insulate the spa for efficient operation, an uncovered spa surface and wall fittings directly exposed to sunlight and high temperatures for an extended period are subject to permanent damage or discoloration. Damage caused by exposing the spa to this abuse is not covered under warranty. We recommend that you always keep the spa full of water when it is exposed to direct sunlight and that you keep the Sundance premium insulating cover in place at all times when the spa is not in use. Read and carefully follow the requirements for your spa's support base found in Section 4.0 titled, "Choosing a Location" (page 9).

Sundance constantly strives to offer the finest spas available, therefore modifications and enhancements may be made which affect the specifications, illustrations and/or instructions contained herein.

2.0 FCC Notice



This equipment has been tested and found to comply with the limits for a Class B Digital Device, pursuant to Part 15 of the FCC Rules. These limits are designed to provide reasonable protection against harmful interference in a residential installation. This equipment generates, uses and can radiate radio frequency energy and, if not installed and used in accordance with the instructions, may cause harmful interference to radio communications. However, there is no guarantee that interference will not occur in a particular installation. If this equipment does cause harmful interference to radio or television reception, which can be determined by turning the equipment off and on, the user is encouraged to try to correct the interference by one or more of the following measures:



1. Rearrange or relocate the receiving antenna.
2. Increase the separation between the equipment and receiver
3. Connect the equipment into an outlet on a circuit different from the circuit connected.
4. Consult the dealer or an experienced radio/TV technician for help. Changes or modifications not expressly approved by the party responsible for FCC compliance could void the user's authority to operate this equipment.



3.0 Important Safety Instructions for all Spa Owners



READ AND FOLLOW ALL INSTRUCTIONS CAREFULLY!

This spa was manufactured to meet the standards and specifications outlined in the “Virginia Graeme Baker Pool and Spa Safety Act” (VGB Safety Act). When installing and using this spa, basic safety precautions should always be followed, including:

-  **DANGER: RISK OF SEVERE INJURY OR DROWNING!**
 - Extreme caution must be exercised to prevent unauthorized access by children.
 - To avoid accidents, ensure that children do not use this spa unless supervised at all times. Adult supervision is a critical safety factor in preventing children from drowning.
 - Use the straps and clip tie downs to secure the spa cover when not in use. This will help discourage unsupervised children from entering the spa. Keep the spa cover secure in high-wind conditions.
 - There is no representation that the cover, clip tie-downs, or actual locks will prevent access to the spa.
-  **DANGER: RISK OF SEVERE INJURY OR DROWNING!**
 - Keep hair, loose articles of clothing or hanging jewelry away from suction fittings, rotating jets or other moving components to avoid entrapment that could lead to drowning or severe injury.
 - Never use the spa unless all suction guards, filter, filter lid, or skimmer assembly are installed to prevent body and/or hair entrapment.
 - Never operate or use the spa if the filter, filter lid, or skimmer assembly are broken or any part of the skimmer assembly is missing. Please contact your dealer or nearest service center for service.
 - The suction fittings and suction covers in this spa are sized to match the specific water flow created by the pump(s). If it is necessary to replace the suction fittings, suction covers or pump(s), be sure that the flow rates are compatible and are in compliance with the VGB Safety Act.
 - Never replace a suction fitting or suction cover with one rated less than the flow rate marked on the original suction fitting. Using improper suction fittings or suction covers can create a body or hair suction entrapment hazard that may lead to drowning or severe injury.
-  **DANGER: RISK OF SEVERE INJURY FROM ELECTRIC SHOCK OR DEATH FROM ELECTROCUTION!**
 - Install the spa at least 5 feet (1.5m), from all metal surfaces. As an alternative, a spa may be installed within 5 feet of metal surfaces if each metal surface is permanently connected (bonded) by a minimum No. 8 AWG (8.4 mm²) solid copper conductor attached to the wire connector on the grounding lug, inside the equipment compartment on the equipment box.

- A grounding wire connector is provided on this unit to connect a minimum No. 8 AWG (8.4 mm²) solid copper conductor between this unit and any metal equipment, metal enclosures of electrical equipment, metal water pipe, or conduit within 5 feet (1.5m) of the unit.
 - Never permit any electrical appliance, such as a light, telephone, radio, television, etc. within 5 feet (1.5m) of a spa unless such appliances are built-in by the manufacturer.
 - Never bring any electrical appliances into or near the spa.
 - Never operate any electrical appliances from inside the spa or when you are wet.
 - The electrical supply for this product must include a suitably rated switch or circuit breaker to open all ungrounded supply conductors to comply with section 422-20 of the National Electrical Code/USA, ANSI/NFPA 70. The disconnecting means must be readily accessible and visible to the spa occupant but installed at least 5 feet (1.5m), from the spa.
 - The electrical circuit supplied for the hot tub must include a suitable ground fault circuit interrupter (GFCI) as required by NEC Article 680-42.
4.  **WARNING: RISK OF SEVERE INJURY OR DEATH!**
- Extreme caution must be exercised to prevent diving or jumping into the spa or slipping and falling, which could result in unconsciousness, drowning, or serious injury. Remember that wet surfaces can be very slippery.
 - Never stand, walk or sit on the top railing of the spa.
5.  **WARNING: RISK OF HYPERTHERMIA (OVER-HEATING) CAUSING SEVERE INJURY, BURNS, WELTS OR DEATH!**
- Water temperature in excess of 104°F (40°C) may be injurious to your health.
 - Refer to Section 3.2 Hypertthermia for specific causes and symptoms of this condition.
 - The water in the spa should never exceed 104°F (40°C). Water temperatures between 100°F (38°C) and 104°F (40°C) are considered safe for a healthy adult.
 - Lower water temperatures are recommended for young children (children are especially sensitive to hot water) and when spa use may exceed 10 minutes.
 - The Consumer Products Safety Commission/USA has stated that the water temperature in a spa should not exceed 104°F (40°C).
 - Always test the spa water temperature before entering the spa. The user should measure the water temperature with an accurate thermometer since the tolerance of water temperature-regulating devices may vary as much as +/- 5°F (2°C).

6.  **WARNING: RISK OF SEVERE INJURY OR DEATH!**
- Since excessive water temperatures have a high potential for causing fetal damage during the early months of pregnancy, if pregnant or possibly pregnant, consult your physician before using a spa.
 - Pregnant or possibly pregnant women should limit spa water temperatures to 100°F (38°C).
 - Persons suffering from obesity or a medical history of heart disease, low or high blood pressure, circulatory system problems, diabetes, infectious diseases or immune deficiency syndromes should consult a physician before using a spa.
 - If you experience breathing difficulties in association with using or operating your spa, discontinue use and consult your physician.
 - Persons using medication should consult a physician before using a spa since some medication may induce drowsiness, while other medication may affect heart rate, blood pressure, and circulation.
 - Persons suffering from any condition requiring medical treatment, the elderly, or infants should consult with a physician before using a spa.
 - The use of alcohol, drugs, or medication before or during spa use may lead to unconsciousness with the possibility of drowning.
7.  **WARNING: RISK OF SEVERE INJURY OR DEATH!**
- Prolonged immersion in a spa may be injurious to your health.
 - Observe a reasonable time limit when using the spa. Exposures at higher temperatures can cause high body temperature (overheating). Symptoms may include dizziness, nausea, fainting, drowsiness, and reduced awareness. These effects could possibly result in drowning or serious injury.
 - Never use a spa immediately following strenuous exercise. Enter and exit the spa slowly. Wet surfaces can be slippery.
8.  **WARNING: TO DECREASE RISK OF INFECTION OR DISEASE!**
- To reduce the risk of contracting a waterborne illness (e.g. an infection, bacteria or virus) and/or respiratory ailments, maintain water chemistry within the parameters listed on the inside cover of this manual and consult with a licensed engineer regarding proper ventilation if installed indoors or in an enclosed area.
 - People with infectious diseases should not use a spa to avoid water contamination, which could result in spreading infections to others.
 - Always shower before and after using your spa. Maintain water chemistry in accordance with manufacturer's instructions. Failure to do so may result in contracting a waterborne illness (e.g. an infection, bacteria or virus).

9.  **WARNING:** In addition to maintenance of filters and water chemistry, proper ventilation is recommended to reduce the risk of contracting a waterborne illness (e.g. an infection, bacteria or virus) and/or respiratory ailments that could be present in the air or water. Consult a licensed architect or building contractor to determine your specific needs if installing your hot tub indoors.
10. **CAUTION: TO DECREASE RISK OF PRODUCT DAMAGE.**
- Maintain water chemistry in accordance with manufacturer's instructions.
 - Proper chemical maintenance of spa water is necessary to maintain safe water and prevent possible damage to spa components.
11.  **WARNING: RISK OF SEVERE INJURY OR DEATH!**
The appliance is not intended for use by persons (including children) with reduced physical, sensory or mental capabilities, or lack of experience or knowledge, unless they have been given supervision or instruction concerning use of the appliance by a person responsible for their safety.
12. **NOTE:** This spa is not intended nor designed to be used in a commercial or public application. The spa buyer shall determine whether there are any code restrictions on the use or installation of this spa since local code requirements vary from one locality to another.

Hot Tub Safety Literature

To ensure you have a safe and enjoyable hot tub experience, learn all you can about hot tub safety and emergency procedures. Especially useful are the brochures listed below:

- [Children Aren't Waterproof](#)
- [Pool and Spa Emergency Procedures For Infants and Children](#)
- [Layers of Protection](#)
- [The Sensible Way to Enjoy Your Spa or Hot Tub](#)

The Association of Pool and Spa Professionals publishes these brochures. To acquire a brochure:

- Ask your hot tub dealer (they may have copies)
- Go to <http://apsp.org>
- Conduct your own search on the internet
- Write to the following address:
The Association of Pool and Spa Professionals
2111 Eisenhower Avenue
Alexandria VA 22314
703.838.0083

3.1 Entrapment Risk

The Consumer Products Safety Commission/USA has reported that users of pools and spas have become entrapped (stuck) to drain and/or suction fittings causing death, drowning, or serious injury (see diagram below). This spa was manufactured to meet the standards and specifications outlined in the “Virginia Graeme Baker Pool and Spa Safety Act” (VGB Safety Act). Entrapment risk can be minimized if proper precautions are taken.



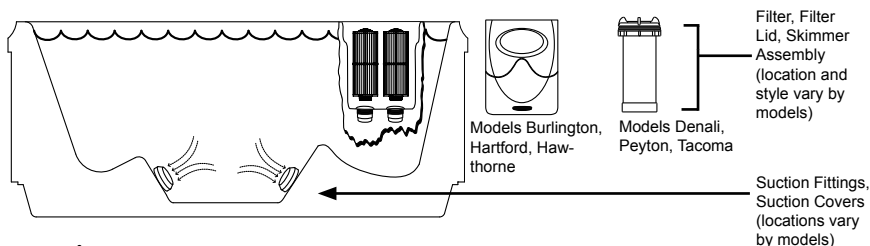

DANGER: RISK OF PERSONAL INJURY OR DEATH!
 Never operate the spa if a suction fitting, suction cover, filter, filter lid or skimmer assembly are broken, damaged or missing.



1.  **DANGER: RISK OF SEVERE INJURY OR DROWNING!**
Hair entrapment: May occur if hair is entangled, knotted or snagged in a drain suction or skimmer assembly. This has been reported in persons who when submerge themselves underwater, allowing hair to come close and/or within the reach of the suction fittings, suction covers or skimmer assembly.
 - Keep hair away from suction fittings, suction covers, filter, filter lid or skimmer assembly.
 - Children are at risk for hair entrapment if swimming under water.
 - Never allow children to play or get near the suction fittings, suction covers, filter, filter lid or skimmer assembly.

2.  **DANGER: RISK OF SEVERE INJURY OR DROWNING!**
Limb entrapment: May occur when a limb becomes entrapped, inserted or sucked into a suction or outlet opening.
 - Always keep suction fittings, suction covers, filter, filter lid or skimmer assembly in place when operating to avoid limb entrapment.
 - Never allow children to play or get near the suction fittings, suction covers, filter, filter lid or skimmer assembly.

3.  **DANGER: RISK OF SEVERE INJURY OR DROWNING!**
Body entrapment: May occur when part of the torso becomes entrapped, inserted or sucked into a suction or outlet opening.
- Never allow children to play or get near the suction fittings, suction covers, filter, filter lid or skimmer assembly.
4.  **DANGER: RISK OF SEVERE INJURY OR DROWNING!**
Evisceration (disembowelment) entrapment: May occur when the buttocks becomes entrapped, inserted or sucked into a suction or outlet opening.
- Never sit on suction fittings, suction covers, filter, filter lid or skimmer assembly.
 - Never allow children to play or get near the suction fittings, suction covers, filter, filter lid or skimmer assembly.
5.  **DANGER: RISK OF SEVERE INJURY OR DROWNING!**
Mechanical entrapment: May occur when jewelry, swimsuit, or hair accessories become entangled, knotted or snagged in a drain suction or skimmer assembly.
- Never allow your jewelry, swimsuit, or hair accessories to come close to the suction fittings, suction covers or skimmer assembly.
 - Never allow children to play or get near the suction fittings, suction covers, filter, filter lid or skimmer assembly.

3.2 Hyperthermia

Prolonged immersion in hot water may induce hyperthermia (overheating). The use of alcohol or drugs can greatly increase the risk of fatal hyperthermia in spas. A description of the causes, symptoms, and effects of hyperthermia are as follows:

Hyperthermia occurs when the internal temperature of the body reaches a level several degrees above the normal body temperature of 98.6°F (37°C). The symptoms of hyperthermia include drowsiness, lethargy (fatigue), and an increase in the internal temperature of the body (feeling of being too hot). The effects of hyperthermia include:

- Unawareness of impending hazard;
- Failure to perceive heat;
- Failure to recognize the need to exit spa;
- Physical inability to exit spa;
- Fetal damage in pregnant women; and
- Unconsciousness and danger of drowning.

A Warning Sign is provided in your warranty packet. Please install at a location near your spa, where it is visible to users of the spa. For additional or replacement Warning Signs please contact your local Sundance spas dealer and reference item number #6530-082.

3.3 Important CSA Safety Instructions (Canada only)

When using this electrical equipment, basic safety precautions should always be followed, including the following:

- 1. READ AND FOLLOW ALL INSTRUCTIONS.**
- A green colored terminal or a terminal marked G, Gr, Ground, Grounding or the  symbol* is located inside the supply terminal box or compartment. To reduce the risk of electric shock, this terminal must be connected to the grounding means provided in the electric supply service panel with a continuous copper wire equivalent in size to the circuit conductors that supply this equipment (*IEC Publication 417, Symbol 5019).
- At least two lugs marked “Bonding Lugs” are provided on the external surface or on the inside of the supply terminal box/ compartment. To reduce the risk of electric shock, connect the local common bonding grid in the area of the spa to these terminals with an insulated or bare copper conductor not smaller than No. 6 AWG (10 mm²).
- All field-installed metal components such as rails, ladders, drains or other similar hardware within 10 feet (3m) of the spa shall be bonded to the equipment grounding buss with copper conductors not smaller than No. 6 AWG (10 mm²).
- 5. SAVE THESE INSTRUCTIONS.**

3.4 General Electrical Safety Instructions

Your new Sundance® spa is equipped with a “state-of-the-art” equipment system. It contains the most advanced safety and self-protective equipment in the industry. Nonetheless, this spa must be installed properly to ensure dependable usage. Please contact your local Sundance dealer or local building department should you have any questions regarding your installation.

Proper grounding is extremely important. Sundance spas are equipped with a current collector system. A pressure wire connector is provided on the surface of the control box, located outside the equipment door (Figure B, page 17) to permit connection of a bonding wire between this point and any ground metal equipment, metal water pipe or conduit within 5 feet (1.5m) of the spa, or copper clad grounding rod buried

within 5 feet (1.5m) of the spa. Bonding wire must be at least No. 8 AWG (8.4 mm²) solid copper wire. This is a most important safety assurance feature.

Before installing your spa, check with your local building department to insure installation conforms to local building codes.

120/240 Volt Denali And Tacoma Convertible Models

A spa connected to a 120 VAC electrical service must be located close enough to a grounded, grounding-type electrical outlet so that the included 10 foot (3m) power cord can be plugged directly into it. **DO NOT USE AN EXTENSION CORD** as this could cause damage to the spa's equipment due to insufficient voltage. The power supplied to this spa must be a dedicated circuit with no other appliances or lights sharing the power provided by the circuit.

4.0 Choosing A Location

IMPORTANT: Because of the combined weight of the spa, water and users, it is extremely important that the base upon which the spa rests be smooth, flat, level and capable of uniformly supporting this weight, without shifting or settling, for the entire time the spa is in place. If the spa is placed on a surface which does not meet these requirements, damage to the skirt and/or the spa shell may result. Damage caused by improper support is not covered under warranty. It is the responsibility of the spa owner to assure the integrity of the support over time. We recommend a poured, reinforced concrete slab with a minimum thickness of 4 inches (10 cm). Wood decking is also acceptable provided it is constructed so that it meets the requirements outlined above.



WARNING: For spas that are to rest on balconies, roofs or other platforms not specifically tied into main structural support, consult a professional Structural Engineer with experience in this type of application.

The spa must be installed in such a manner as to provide drainage away from it. Placing the spa in a depression without provisions for proper drainage could allow rain, overflow and other casual water to flood the equipment and create a wet condition in which it would sit in. For spas

which will be recessed into a floor or deck, install so as to permit access to the equipment, either from above or below, for servicing. Make certain that there are no obstructions which would prevent removal of all side cabinet panels and access to the jets components, especially on the side with the equipment bay.



CAUTION: If the spa is indoors or located in an enclosed area, proper ventilation should be discussed with an Engineer or authority competent enough to understand the necessary provisions needed to vent moist or heated air and air associated with chemical odors outdoors. **When the spa is in use considerable amounts of moisture will escape potentially causing mold and mildew.** This can cause health risk. Over time, this can damage certain surfaces, surroundings, and equipment.

4.1 Outdoor Location

In selecting the ideal outdoor location for your spa, we suggest that you take into consideration the following:

- The proximity to changing area and shelter (especially in regions subject to cold weather).
- The pathway to and from your spa (this should be free of debris so that dirt and leaves are not easily tracked into the spa).
- The closeness to trees and shrubbery (remember that leaves and birds could create extra work in keeping the spa clean).
- A sheltered environment (less wind and weather exposure can result in lowered operation and maintenance costs).
- The overall enhancement of your environment. It is preferable not to place the spa under an unguttered roof overhang since run-off water will shorten the life expectancy of the spa cover.
- For spas that are to rest on balconies, roofs or other platforms not specifically tied into main structural support, consult a professional Structural Engineer with experience in this type of application.
- In the unlikely event that you should ever need to access or gain entry to any portion of the spa for servicing, it is highly recommended that you plan your outdoor installation to provide full access to the entire spa. Please take this into consideration when placing the spa in a deck or enclosed by a surrounding.
- Consider locating your spa away from any reflective surface or glass to prevent any damage to the synthetic skirt.

4.2 Indoor Location

For indoor installations many factors need to be considered before installing a spa indoors:



WARNING: In addition to maintenance of filters and water chemistry, proper ventilation is recommended to reduce the risk of contracting a waterborne illness (e.g. an infection, bacteria or virus) and/or respiratory ailments that could be present in the air or water. Consult a licensed architect or building contractor to determine your specific needs if installing your hot tub indoors.

- **PROPER FOUNDATION:** Consult a Structural Engineer when considering a foundation that will adequately support the spa the entire time it is in place. Proper support is critical especially if the spa is to rest on a second story or higher. For spas that are to rest on balconies, roofs or other platforms not specifically tied into the main structural support, you should consult a professional Structural Engineer with experience in this type of application.
- **PROPER DRAINAGE:** It is extremely important to have in place measures to sufficiently handle excessive water spillage. Be sure the flooring in which the spa rests on has adequate drainage and can handle draining of the entire contents of the spa. Be sure to make provisions for ceilings or any other structures that may be below the spas installation. Areas around your spa can become wet or moist so all flooring and subsequent furniture, walls and adjacent structures should be able to withstand or resist water and moisture.
- **PROPER VENTILATION:** Proper ventilation should be discussed with an Engineer or authority competent enough to understand the necessary provisions needed to vent moist or heated air and air associated with chemical odors outdoors. When the spa is in use considerable amounts of moisture will escape potentially causing mold and mildew, over time this can damage certain surfaces and or surroundings.
- **SUFFICIENT ACCESS:** In the unlikely event that you should ever need to access or gain entry to any portion of the spa for servicing, it is highly recommended that you plan your indoor installation to provide full access to the entire spa.
- **WARRANTY:** Damage caused by not following these guidelines or any improper installation not in accordance with local codes or authorities is not covered under the spas warranty. Please consult your local state or city building ordinances.

5.0 Power Requirements

Sundance® spas are designed to provide optimum performance and flexibility of use when connected to the maximum electrical service listed on pages 12-14. If you prefer, your dealer can perform a minor circuit board modification to allow your spa to accept an electrical service other than the factory setting.

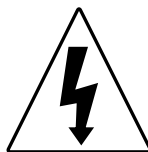

Note: Refer to pages 50-57 for circuit board configuration details or contact your authorized Sundance dealer.

5.1 North American 60 Hz Power Options

North American Denali/Tacoma 1-Pump Convertible Models (60 Hz)

	<u>120V/15A*</u>	<u>240V/30A*</u>	<u>240V/40A**</u>
Voltage:	120 VAC	240 VAC	240 VAC
# of Wires:	3 (15A GFCI Cord - US Models Only*)	4 (Hard Wired Only)	4 (Hard Wired Only)
Frequency:	60 Hz	60 Hz	60 Hz
Current Draw:	12A	21A	30A
Circuit Breaker:	15A, 1-Pole	30A, 2-Pole	40A, 2-Pole

CAUTION (For 4-wire, 240 VAC Heater Operation): Move the red wire on the main terminal strip (TB1) from position #1 to position #3. Make certain wires are connected exactly as shown in Figure D (page 17) before applying power. Failure to do so will result in damage to the circuit board and/or related components and void the manufacturer's warranty.

* In the 15A/30A configuration, the heater **will not operate** at the same time as the high-speed jets pump. **The factory setting is 120V/15A.**

***Note: all Canadian spas must be hard wired (120 VAC or 240 VAC) per CSA Canadian standards (page 8).**

** If the spa is to be operated on 40A service, remove the jumper JP1 #1-2 on the circuit board to allow the heater to operate at the same time as the high-speed jets pump (page 50).

North American Burlington 1-Pump Models (60 Hz)

	<u>240V/40A*</u>	<u>240V/50A**</u>
Voltage:	240 VAC	240 VAC
# of Wires:	3	3
Frequency:	60 Hz	60 Hz
Current Draw:	26A	36A
Circuit Breaker:	40A, 2-Pole	50A, 2-Pole

* In the 40A configuration, the heater **will not operate** while the jets pump is running in high speed.

** In the 50A configuration, the heater **will operate** while the jets pump is running in high speed. **This is the factory setting.**

North American Hartford/Hawthorne/Peyton 2-Pump Models (60 Hz)

	<u>240V/40A*</u>	<u>240V/50A**</u>	<u>240V/60A***</u>
Voltage:	240 VAC	240 VAC	240 VAC
# of Wires:	3	3	3
Frequency:	60 Hz	60 Hz	60 Hz
Current Draw:	26A	36A	45A
Circuit Breaker:	40A, 2-Pole	50A, 2-Pole	60A, 2-Pole

* In 40A configuration, the heater **will not operate** while either jets pump is running in high speed. **Note: pump 2 runs only in high speed.**

** In 50A configuration, the heater **will not operate** while both jets pumps are running in high speed. **Note: pump 2 runs only in high speed. This is the factory setting.**

*** In 60A configuration, the heater **will operate** while both jets pumps are running in high speed. **Note: pump 2 runs only in high speed.**

5.2 Export 50 Hz Power Options

Export Burlington/Denali/Tacoma 1-Pump Models (50 Hz)

	<u>230V/20A*</u>	<u>230V/30A**</u>
Voltage:	230 VAC	230 VAC
# of Wires:	3	3
Frequency:	50 Hz	50 Hz
Current Draw:	15A	21A
Circuit Breaker:	20A	30A

* In the 20A configuration, the heater **will not operate** while the jets pump is running in high speed. **This is the factory setting.**

** In the 30A configuration, the heater **will operate** while the jets pump is running in high speed.

Export Hartford/Hawthorne/Peyton 2-Pump Models (50 Hz)

	<u>230V/20A*</u>	<u>230V/30A**</u>	<u>230V/40A***</u>
Voltage:	230 VAC	230 VAC	230 VAC
# of Wires:	3	3	3
Frequency:	50 Hz	50 Hz	50 Hz
Current Draw:	15A	23A	29A
Circuit Breaker:	20A	30A	40A

* In the 20A configuration, the heater **will not operate** while either jets pump is running in high speed. **This is the factory setting.**

** In the 30A configuration, the heater **will not operate** while both jets pumps are running in high speed.

*** In the 40A configuration, the heater **will operate** while both jets pumps are running in high speed.

6.0 Electrical Wiring Instructions

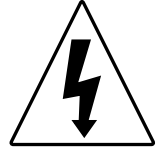

IMPORTANT NOTICE: The electrical wiring of this spa must meet the requirements of the National Electrical Code/ USA (NEC) and any applicable state or local codes. The electrical circuit must be installed by a qualified electrician and approved by a local building/electrical inspection authority.

1. Convertible 120/240V Denali/Tacoma Models Only:

-  **DANGER: TO DECREASE THE RISK OF SHOCK, PRODUCT DAMAGE OR ELECTRICAL FIRE.**

120V “Plug-in” Operation: This spa must operate on the supplied 10 feet (3m) 120V GFCI cord at its original length or must be hard-wired for longer runs. **NEVER USE AN EXTENSION CORD FOR ANY REASON!**

- Convertible 120/240V Heater Operation: The included 120V GFCI cord must be discarded for 240V heater operation. This spa must be hard-wired. Supplying power to either configuration above which is not in accordance with these instructions will void both the independent testing agency listing and the manufacturer’s warranty.

2. Dedicated 240V Burlington, Hartford and Hawthorne Models:

This spa must be permanently connected (hard-wired) to the power supply. No plug-in connections or extension cords are to be used in conjunction with the operation of this spa. Supplying power to the spa which is not in accordance with these instructions will void both the independent testing agency listing and the manufacturer’s warranty.

3. The power supplied to this spa must be a dedicated circuit with no other appliances or lights sharing the power provided by the circuit.

4. To determine the current, voltage and wire size required, refer to Section 5.0 “Power Requirements” (pages 12-14).

- Wire size must be appropriate per NEC and/or local codes.
- We recommend type THHN wire.
- All wiring must be copper to ensure proper connections. **Do not use aluminum wire.**
- When using wire larger than #6 (10 mm²), add a junction box near the spa and reduce to short lengths of #8 (8.4 mm²) wire to connect to the spa.

5. The electrical supply for this product must include a suitably rated switch or circuit breaker to open all ungrounded supply conductors to comply with Section 422-20 of the National Electrical Code/USA, ANSI/NFPA 70. The disconnecting means must be readily accessible to the spa's occupant but installed at least 5 feet (1.5m) from spa water.
6. The electrical circuit supplied for the spa must include a suitable ground fault circuit interrupter (GFCI) as required by NEC Article 680-42.
7. To gain access to the spa's power terminal block, remove the screws securing the cabinet panel on the side of the spa under the control panel. Then remove the four control box door screws and door (Figures A-B, pages 16-17).
8. Select the power supply inlet you want to use (Figure A). Feed power cable to control box, then install it through the large opening provided in the bottom side of the box.
9. Connect wires, color to color, on terminal blocks TB1 and TB3 (Figures C-F, page 17). TIGHTEN SECURELY! All wires must be hooked up securely or damage could result.
10. Install control box door and screws and reinstall the cabinet side panels.

Figure A
Equipment Area

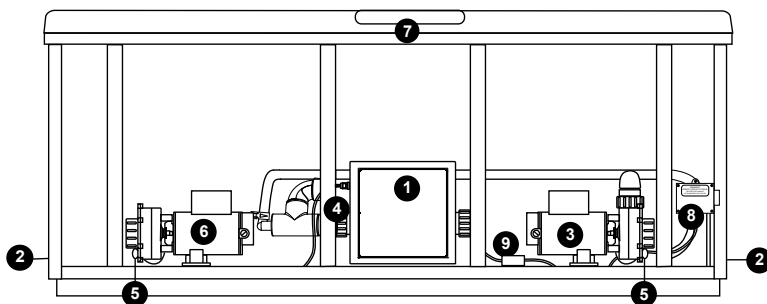

Note: Equipment location (such as pumps, CLEARRAY™ system, drain, heater etc.) varies by model.

- | | |
|--------------------------|---|
| 1. Control Box | 6. 1-Speed Pump |
| 2. Power Supply Inlet(s) | 7. Control Panel |
| 3. 2-Speed Pump | 8. CLEARRAY (Ultraviolet) Water Purification System |
| 4. Heater | 9. Electronic Ballast (For the CLEARRAY System) |
| 5. Pump Drain Plugs | (Model shown with Hi-Flow heater and no circulation pump) |

Figure B
Control Box

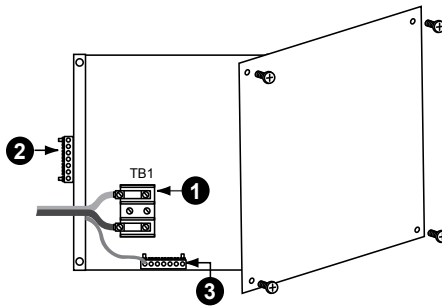

1. Terminal Block
2. Bonding Lug
3. Grounding Terminal

Figure C

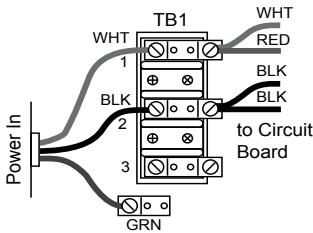

North American Denali/Tacoma Convertible Models: 120 VAC, 3-Wire Connection (60 Hz)

Figure D

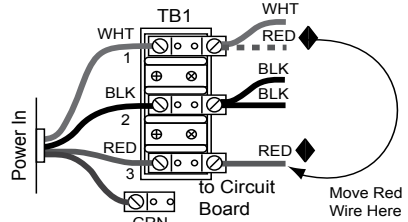

North American Denali/Tacoma Convertible Models: 240 VAC, 4-Wire Connection (60 Hz)

◆ **CAUTION (For 4-wire 240 VAC Heater Operation):** Move the red wire on the main terminal strip (TB1) from position #1 to position #3. Make certain wires are connected exactly as shown in Figure D before applying power. Failure to do so will result in damage to the circuit board and/or related components and void the manufacturer's warranty.

Figure E

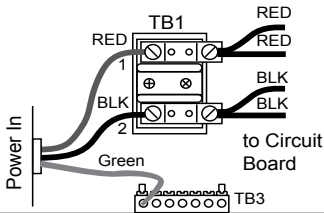

North American Models : 240 VAC, 3-Wire Connection (60 Hz)

Figure F

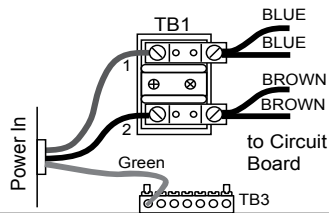

All Export Models: 230 VAC, 3-Wire (50 Hz)

7.0 Spa Fill Up Procedure

For best results, read each step in its entirety before proceeding with that step.

1. Prepare The Spa For Filling

- Clear all debris from the spa. (Although the spa shell has been polished at the factory, you may want to treat it with a specially formulated spa cleaner). Consult your authorized Sundance dealer for additional information prior to filling spa.
- Remove filter/skimmer lid (pages 24 and 25), then remove filter cartridge as outlined in Section 11.1 (page 36).

2. Fill Spa

- Place the end of your garden hose into the empty filter bucket.

CAUTION: TO DECREASE BUILD UP ON COMPONENTS AND MINIMIZE ACRYLIC DAMAGE.

Never fill with water from a water softener. If your water is extremely “hard”, it is preferable to fill half-way with hard water and the rest of the way with softened water. Water that is too soft can be corrosive to metal components.

-  **WARNING: TO DECREASE RISK OF INFECTION OR DISEASE.**

Fill hot tub with clean tap water from garden hose, to reduce risk of contracting a waterborne illness (e.g. an infection, bacteria or virus) and/or respiratory ailments. Fill until water covers all jets but does not touch the bottom of the lowest headrest. (DO NOT OVERFILL!)

IMPORTANT: Always fill your spa through the filter bucket after draining. Failure to do so may cause air to be trapped in either pump, preventing the pump from circulating water. Remove the hose and replace the filter cartridge. Note: DO NOT overtighten filter cartridge, finger tight only!

3. Turn On Power

Turn on power to spa at the home's circuit breaker to start boot up sequence (Section 9.0, page 26). The heater and filter pump will automatically activate after several seconds. If the control panel LED flashes water temperature and “COL” or “ICE” this is normal, refer to page 47 for additional information.

Note: “COL” and “ICE” will only appear when the spa is in Economy mode.

4. **Activate Jets Pumps**

Turn on all jet(s) pumps to ensure proper mixing when adding start-up chemical in step 5.

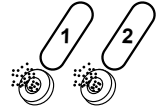

5. **Add Start-Up Chemicals**

Add the spa water chemicals as recommended by your authorized Sundance dealer. See Section titled “Water Quality Maintenance” (page 41) for general guidance.



WARNING: RISK OF POISONING OR DEATH.

Never leave chemicals opened and accessible to anyone. Use chemicals according to the vendors instructions. Always store chemicals in a safe and/or locked location. Keep away from and out of reach of children.

6. **Establish A Stable Sanitizer Reading**



Establish a stable sanitizer reading no less than 1.0 ppm chlorine or 2.0 ppm bromine. To ensure healthy water conditions, always maintain a constant sanitizer reading within the levels recommended on the inside cover of this manual. If sanitizer levels cannot be stabilized, perform the decontamination procedure steps 9-15 on the following page.

Note: The “decontamination procedure” steps 9-15 should also be used after the spa has been “Winterized” (Section 11.7, page 40) or has been sitting without power for an extended period.

7. **Set Spa To Heat**

To warm spa water to a comfortable temperature, follow these steps:



- The LED display on the control panel displays the actual temperature of the spa water. Press either the **COOLER** () or **WARMER** () button once to display the “set” temperature for 5 seconds. If you want the water to heat to a different temperature, simply press **COOLER** or **WARMER** within 5 seconds. The set temperature increases or decreases by one degree each time one of these buttons is pressed.
- The heater will turn off when the temperature corresponding to the thermostat setting is achieved.

Important Heater Details:

- The maximum temperature for which the spa can be set is 104°F (40°C) and the minimum is 65°F (18°C).
- For North American (60 Hz) 2-pump spas powered by a 40 amp service, jets pump #1 must be set to low speed and jets pump #2 must be turned off to operate the heater.
- For Export (50 Hz) 2-pump spas powered by a 20 amp service, jet pump #1 must be set to low speed and jets pump #2 must be turned off to operate the heater.
- Setting the thermostat at maximum will not accelerate the heating process. This will only result in a higher ultimate temperature.
- The heater operates until the water reaches the programmed “set temperature”, then turns off. The heater will reactivate after the water cools to approximately 1.5° below the “set temperature.”

8. Place Cover On Spa

- Keeping the insulating cover in place anytime the spa is not in use will reduce the time required for heating, thereby minimizing operating costs.
- The time required for initial heat-up will vary depending on the starting water temperature.



DANGER: RISK OF PERSONAL INJURY.

Check water temperature carefully before entering hot tub! Excessive water temperature can cause burns, welts and body temperature to rise, hyperthermia (over-heating).

Decontamination Procedure (Steps 9-15)

Steps 9-15 below are only required when sanitizer levels are unstable after performing steps 1-6 above. Disregard steps 9-15 below if sanitizer levels remain stable within the levels recommended on the inside cover of this manual.

9. Add 2.5 ounces (71 g) of sodium dichlor for every 100 gallons (378 Liters) of water. Refer to the table below for approximate water fill volume by model.



CAUTION: RISK OF PERSONAL INJURY OR SPA DAMAGE!

Never add chlorine tablets (trichlor) or acid to your hot tub for any reason! These chemicals may damage components within your hot tub, burn or irritate your skin, create a rash, and void the manufacturer warranty for your spa.

Water Volume by Model

Model	Average Fill Volume*	Sodium Dichlor
Denali	230 Gal (871 L)	6.0 oz.
Tacoma	147 Gal (557 L)	4.0 oz.
Burlington	350 Gal (1,325 L)	9.0 oz.
Hartford	390 Gal (1,476 L)	10.0 oz.
Hawthorne	430 Gal (1,628 L)	11.0 oz.
Peyton	340 Gal (1,287 L)	9.0 oz.

*Use average fill volume for chemical maintenance

10. Leave spa cover open during this step to allow excessive chemical vapors to exit spa, protecting plastic knobs and pillows on Burlington, Hartford, Hawthorne, Peyton and Tacoma models from chemical attack. If spa is indoors, open doors and windows for proper ventilation. Turn on all spa jets pumps for one hour, open all air controls. On Burlington, Hartford, Hawthorne and Peyton (Figure A) and Denali (Figure B) models, place the Massage Selector or Diverter Jet in their center "combo" position as shown (right).

Massage Selector

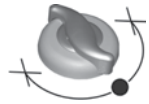

Figure A

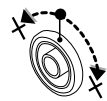

Figure B



Set all air controls to their full open counterclockwise position

Note: You will need to press the jets pump button(s) every 20 minutes since these functions have an automatic 20 minute time-out function that turns them off.



WARNING: BECAUSE OF THE RISK OF INHALING CHEMICAL VAPORS.

- To decrease the risk of injury, drowning or entrapment, never leave your hot tub unattended for any reason while the cover is open and accessible, especially to small children and animals!
- Precautions should be taken to minimize your exposure to chemical vapors (that could cause lung, brain, or skin damage).

11. Turn off power to the spa at the circuit breaker, then drain spa as outlined in Section 11.2 (page 37).
12. Refill spa with clean tap water from garden hose until water covers all jets. (DO NOT OVERFILL!)

CAUTION: TO DECREASE BUILD UP ON COMPONENTS AND MINIMIZE ACRYLIC DAMAGE.

Never fill with water from a water softener. If your water is extremely “hard”, it is preferable to fill half-way with hard water and the rest of the way with softened water. Water that is too soft can be corrosive to metal components.

13. Consult your authorized Sundance dealer for chemical recommendations, then add chemicals to spa water to achieve a constant sanitizer reading within the levels recommended on the inside cover of this manual.
14. Turn on all jet pumps when adding chemicals to ensure proper mixing and leave your spa cover open until the sanitizer level becomes stable to protect pillows and plastic knobs from chemical attack. Refer to the inside cover of the manual.

**WARNING: RISK OF PERSONAL INJURY.**

- To decrease the risk of injury, entrapment or drowning, never leave your hot tub unattended for any reason, especially if while the cover is open and accessible to small children and animals!
- To decrease the risk of contracting a waterborne illness (e.g. an infection, bacteria or virus) and/or respiratory ailments, maintain water chemistry within 6 step parameters. If you or other bathers experience such a condition, discontinue use and seek immediate medical attention.

15. Establish a sanitizer reading no less than 1.0 ppm free chlorine or 2.0 ppm bromine, then allow the hot tub to set undisturbed for 8 hours. Retest water after 8 hours to determine if sanitizer levels are stable. If sanitizer levels are stable, your spa is ready for use. To ensure healthy water conditions, always maintain a constant sanitizer reading within the levels recommended on the inside cover of this manual. If sanitizer levels are not stable at this time, it will be necessary to repeat this procedure in its entirety (steps 1-15) until stable sanitizer readings are achieved.

IMPORTANT: If the CLEARRAY™ water purification system is removed from the hot tub or is not operating effectively follow the “without CLEARRAY™” water chemistry parameters as defined by the Association of Pool and Spa Professionals.

16. After adequate sanitizer levels are achieved, close all spa air controls to maximize heat retention when spa is not in use.



8.0 Control Functions

8.1 Control Panel

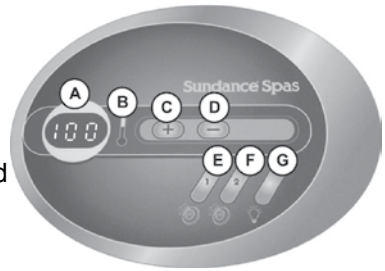
- A. **LED Display:** Can display current water temperature (default display), water temperature set point, selected filtration/heating mode, and error messages.



2 Pump Panel Shown

- B. **Heat Indicator:** Lit when heater is on.
- C. **Warmer () Button:** Increases water temperature set point.
- D. **Cooler () Button:** Decreases water temperature set point.
- E. **Jets 1 Button:** Turns jets pump #1 on and off. Press once for low speed; press a second time for high speed; press a third time to turn pump off.
- F. **Jets 2 Button (if equipped):** Turns jets pump #2 on and off. Press once for high speed; press a second time to turn pump off.
- G. **Light Button:**
- Denali and Tacoma Models: Turns underwater light on in random mode or in one of six solid colors. Refer to Section 9.3 (page 27) for details.
 - Burlington, Hartford, Hawthorne, and Peyton Models: Turns underwater light (if equipped) and accent lights on in one of three random modes or one of seven solid colors. Refer to Section 9.4 (page 28) for details.

Operation Details

- Temperature Adjustment: 65 to 104°F (18 to 40°C). Factory default setting is 100°F (38°C).
- All lighting systems run for 1 hour then shut off.
- Jets 1/Jets 2 Button Operation: Jets run for 20 minutes after activated, then turn off automatically to conserve energy. Simply press either jets button to continue operation for an additional 20 minutes.

8.2 General Spa Features And Controls

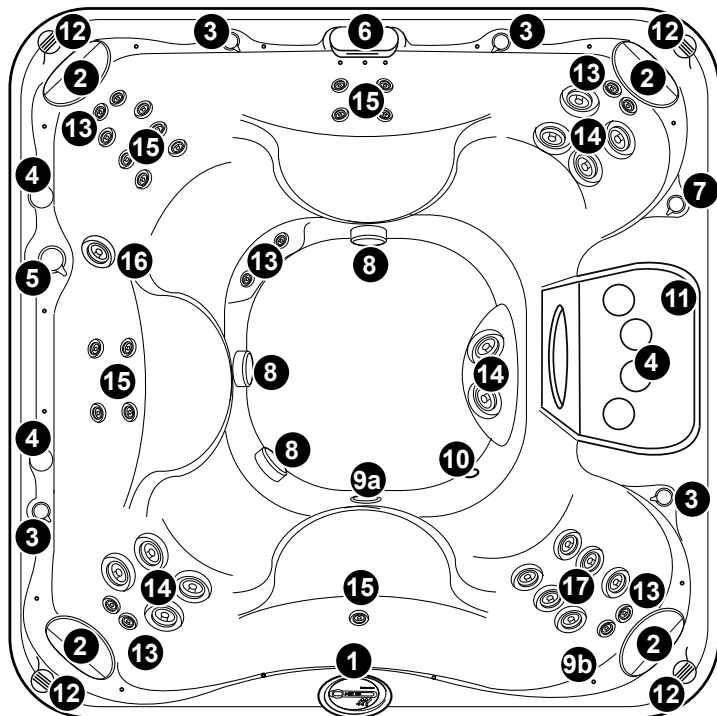

12 ↑ Hartford model illustrated - Jet locations and features will vary by model. Specifications subject to change without notice.

1. Control Panel
2. Headrest Pillows (4 ea.)
3. Air Controls (4 ea.)
4. Cup Holders (6 ea.)
5. Massage Selector (1 ea.)
6. Waterfall
7. Waterfall control valve (1 ea.)
8. Suction Fittings
9. Lighting System Options:
 - LED lighting system includes LED footwell light (9a)
 - Multiple LED accents lights (9b qty 22).
10. Gravity Drain: Fitting functions as floor gravity drain, heater return and CLEARRAY purification system return.
11. Filter lid with four cup holders and two underlying filter cartridges.
 - Spas without the circulation pump option utilize both filter cartridges for jets pump 1.
 - Spas with the circulation pump option utilize one filter cartridge closest to waterfall valve (7) for jets pump 1 and the second cartridge for the circulation pump.
12. Optional audio system speakers (4 ea.) and AM/FM/iPod stereo deck (1 ea.) located on front spa skirt.
13. DX Jets (10 ea.)
14. DVX Jets (10 ea.)
15. DL Jets (15 ea.)
16. DST Jet (1 ea.)
17. DXL Jets (6 ea.)

8.3 General Spa Features And Controls (Peyton Model)

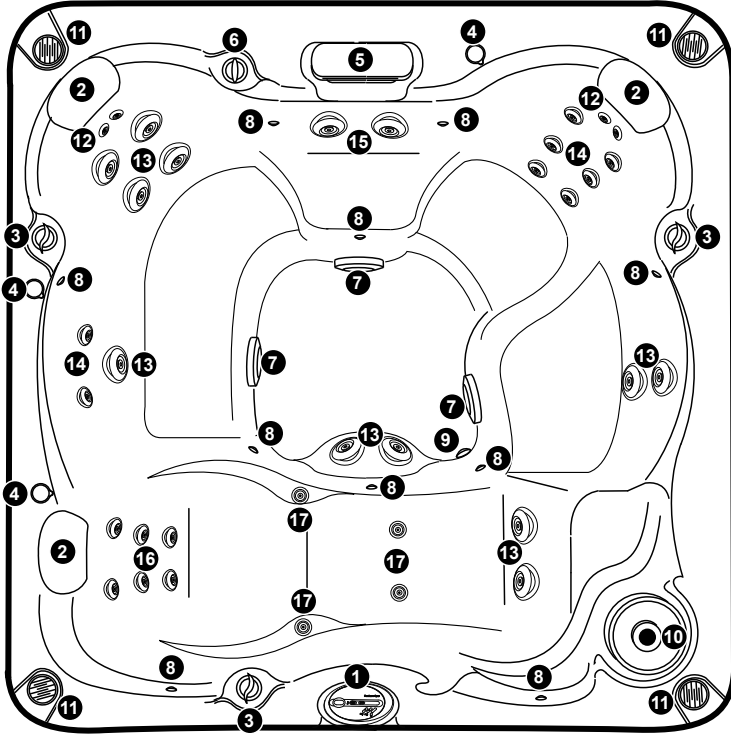







Jet locations and features may vary. Specifications subject to change without notice.

- | | |
|--|---|
| 1. Control Panel | 10. Filter skimmer with one underlying filter cartridge (Filter needs periodic cleaning) |
| 2. Headrest Pillows (3 ea.) | 11. Optional audio system speakers (4 ea.) and AM/FM/iPod stereo deck (1 ea.) located on front spa skirt. |
| 3. Air Controls (3 ea.) | 12. DX Jets (4 ea.) |
| 4. Cup Holders (3 ea.) | 13. DVX Jets (11 ea.) |
| 5. Waterfall | 14. DL Jets (8 ea.) |
| 6. Waterfall control valve (1 ea.) | 15. DXT Jets (2 ea.) |
| 7. Suction Fittings | 16. DXL Jets (6 ea.) |
| 8. Multiple LED accents lights (10 ea.) | 17. DV Jets (4 ea.) |
| 9. Gravity Drain: Fitting functions as floor gravity drain, heater return and CLEARRAY purification system return. | |

9.0 Operating Instructions



The spa control system has automatic functions that operate upon start-up and normal operation to protect the system. Upon power up, the readout displays the following information:

1. Control panel displays current software release (e.g. 3.59 or 5.58 depending on spa model), then;
2. Control panel displays "888" and all indicator LEDs are lit, permitting visual inspection of all display segments and indicator lights for proper operation.
3. After the initial start-up sequence ends, the actual water temperature is displayed. If water temperature at this time is less than the factory default temperature setting of 100°F (38°C) and the spa is set to either of the standard filtration/heating modes (pages 31 and 32), the heater will turn on and run until the water temperature rises to the factory setting, then turn off.

	Spa with Circulation Pump Option	Spa without Circulation Pump Option
1.		
2.		
3.		

Note: It is common for the heater to turn on after the spa is first filled because tap water is often very cold.

9.1 Setting Water Temperature

The spa's thermostat provides optimum control of water temperature. The temperature setpoint (set temperature) can be adjusted from 65°F to 104°F (18°C to 40°C). To raise the set temperature, press the **WARMER** () button. To lower the set temperature, press the **COOLER** () button. The first press of either button displays the set temperature. To access the overtemp feature that allows the spa to reach 106°F (41°C) follow the steps below (Figure 1).

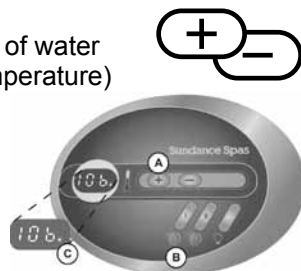





Figure 1



**WARNING: RISK OF HYPERTHERMIA (OVER-HEATING)
CAUSING SEVERE INJURY, BURNS, WELTS OR DEATH!**

Water temperature in excess of 104°F (40°C) may be injurious to your health.

- A. Press and hold the **WARMER** () button then;
- B. Press and hold the **JETS 1** () button at the same time for 2 seconds. You will see the temperature rise to 106°F (41°C) on the LED display. To lower the temperature, press the **COOLER** () button.

- C. When the overtemp feature has been activated, the white decimal point after the last digit will flash on and off every second as an indicator for being in the overtemp mode.

Note: Once the temperature goes below 104°F (40°C) and you would like to raise the temperature to 106°F (41°C) again, you will have to repeat the steps above.

9.2 Activate Pumps

The **JETS 1** button activates the jets pump 1. The first press activates in low speed, the second press activates high speed, and the third press shuts the pump off. The **JETS 2** button (if equipped) activates jets pump 2 which only operates in high speed. When manually activated, both pumps automatically turn off in 20 minutes.

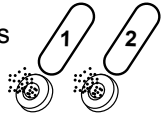

9.3 SunGlow™ Light Operation (Denali and Tacoma Models)

The spa light offers 6 constant color variations and a unique random mode for enhanced spa enjoyment. Press the Light button once to turn the spa light on in Random mode, then repeatedly press the button to turn the light off or to select one of 6 constant colors as illustrated below.

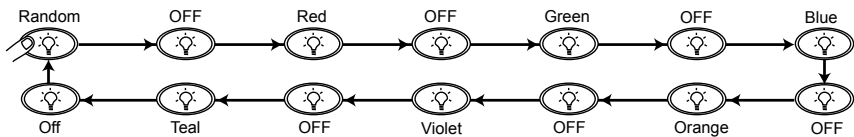

You must press the LIGHT button within 5 seconds between each “off” or “color” selection to prevent it from resetting. Pressing the button after 5 seconds restarts the sequence in Random mode. This mode automatically changes the light color every 8 to 20 seconds.

Note: Any time the spa light is manually turned on, it will automatically turn off after approximately 1 hour. If you desire more light at this time, simply turn the light back on.

9.4 Multi-Colored LED Light System Operation (Burlington, Hartford, Hawthorne, and Peyton Models)

The multi-colored LED spa light offers seven constant color variations and three unique random modes for enhanced spa enjoyment. Press the light button once to activate the first light mode Random Fade, then continue pressing the button to either turn the light off or to select one of seven constant colors, random solid color mode or strobe mode as illustrated.

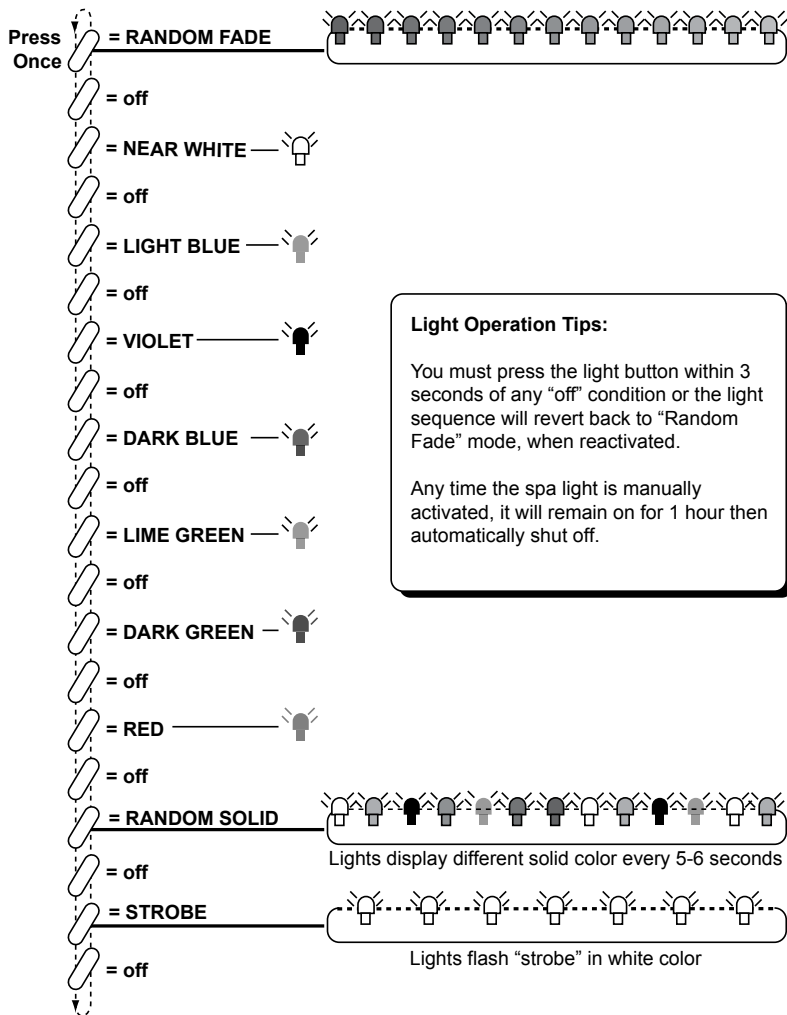

Light Operation Tips:

You must press the light button within 3 seconds of any "off" condition or the light sequence will revert back to "Random Fade" mode, when reactivated.

Any time the spa light is manually activated, it will remain on for 1 hour then automatically shut off.

9.5 Adjusting Individual Jet Flow

The water flow through certain jets in your spa can be adjusted or turned off by rotating the outside jet ring. These jets include:

- DXL Jet
- DL Jet
- DX Jet
- DV Jet

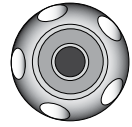

DST Jet

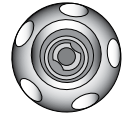

DVX Jet



DV Jet

Other jets also offer an adjustable center nozzle that allows you to change the water discharge angle. Simply tilt the center nozzle in these jets to the desired angle to customize your personal massage. These jets include:

- DXL Jet
- DVX Jet
- DST Jet
- DV Jet

Note: Always keep at least 6 adjustable jets open at all times to ensure proper filtration characteristics within spa.

9.6 Selecting Desired Massage Action

All models (except Tacoma) incorporate a massage selector valve or Diverter Jet that allows you to customize the massage and performance by diverting water between various jet systems within the spa. Simply turn valve to positions A, B or C to divert water pressure to various jet groups.

Note: The valve is intended to operate in positions A (Combo), B, or C for optimum performance. It is considered normal for sound levels within the valve to increase between these positions due to the large amounts of water flowing through it. For optimum filtration benefits, always leave this valve in position A when the spa is covered and select positions B or C for maximum jet performance during spa use.

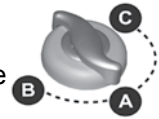

Burlington, Hartford, Hawthorne, and Peyton models

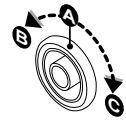

Denali model

9.7 Air Controls

Certain jet systems have their own air control. Each control introduces air into the water lines that supply that specific jet group. Simply turn the air control selection to open or close. To minimize heat loss, all air controls should be closed when the spa is not in use.



Burlington, Hartford, Hawthorne, and Peyton models



Denali model

9.8 Optional Audio System

Models equipped with the optional audio system offer enhanced spa enjoyment. These models include a high-quality AM/FM/iPod® stereo receiver with four high-quality marine speakers for unsurpassed sound quality and long-life. Refer to the manufacturers operating instructions included in the warranty pack.



10.0 Automatic Filtration Cycles

The control system activates a programmable “Standard” or “Economy” filtration cycle to remove debris from your spa. These cycles use the low speed pump, skimmer basket, and filter cartridge quickly clear “skim” the water of debris and minimize their “bathtub ring” affect. Apart from their filtration benefit, each mode also effects the operation of your spa’s heater. Refer to Sections 10.1-10.3 below for additional information.

10.1 Standard Filtration/Heating Modes For Models Without Circulation Pump Option

Standard filtration/heating modes (F1-F3) are typically selected by customers in cold climates where heat up times are extended due to lower ambient temperatures. In either of these modes, the set temperature regulates the water temperature. The low-speed jets pump 1 and heater turn on as needed. After the programmed set temperature is reached, the heater and low speed pump turn off; only to turn back on during a heat call and/or during the next programmed filtration/heating cycle.

10.2 Standard Filtration/Heating Modes For Models With Circulation Pump Option

Standard filtration/heating modes (F0-F3) are typically selected by customers in cold climates where heat up times are extended due to lower ambient temperatures. In either of these modes, the water temperature is regulated by the set temperature. The 24-hour circulation pump and heater turn on as needed.

10.3 Economy Filtration/Heating Modes (F4-F6)



Economy filtration/heating modes are typically selected by customers in warm climates where heat up times are minimized due to higher ambient temperatures. In these modes, the water temperature is regulated by the set temperature only during a programmed filtration/heating cycle. The heater will turn on only when there is a heat call during a programmed filtration/heating cycle.



Note: These modes consume less energy than standard modes F1-F3 outlined above.

10.4 Lock Modes (L1-L2)

These modes are designed for use during spa service or to prevent unauthorized use.

10.5 Selecting The Filtration/Heating Mode

Press and hold both control panel **WARMER** () and **COOLER** () buttons at the same time, then release.

Then press either **WARMER** () or **COOLER** () button to select filtration/heating mode F1-F6 or lock modes L1-L2 on the following pages.

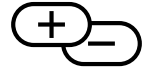

10.6 Filtration Modes for Spas Without Circulation Pump Option

If your spa is equipped with the circulation pump option, disregard this section and refer to page 32 for filter cycle programming details.

During the filtration/heating cycle the Jets pump 1 low speed will activate.

Standard Filtration/Heating Modes (F1-F3)

F1 4 hours of filtration/heating per day (one 2-hour cycle every 12 hours).

F2 6 hours of filtration/heating per day (one 2-hour cycle every 8 hours).

F3 8 hours of filtration/heating per day (one 2-hour cycle every 6 hours).



Economy Filtration/Heating Modes (F4-F6)

F4 4 hours of filtration/heating per day (one 2-hour cycle every 12 hours).

F5 6 hours of filtration/heating per day (one 2-hour cycle every 8 hours).

F6 8 hours of filtration/heating per day (one 2-hour cycle every 6 hours).



Lock Modes (L1-L2)

L1 Lock Out (disables all spa functions to permit filter cleaning).

L2 Lock Mode (disables the jets and light buttons to prevent unauthorized use of spa). Filtration/heating cycle will continue to operate as programmed in this mode. The temperature display flashes when this function is enable. Example: the "F3" filtration/heating cycle was enabled prior to choosing lock mode. The spa continues to perform the "F3" cycle until lock mode is canceled, allowing another cycle to be selected.



Filter Cycle Setup Example

To set a time for the first filtration/heating cycle, simply turn power on to the spa two minutes prior to the desired time. Example: If you desire your first filtration/heating cycle to begin at 10:00 AM turn off power to the spa and turn it back on again at 9:58 AM.

Note: Start time is approximate and may vary slightly from day to day.

10.7 Filtration Modes for Spas With Circulation Pump Option

If your spa is not equipped with the circulation pump option, disregard this section and refer to page 31 for filter cycle programming details.

During the filtration/heating cycle the jets pump 1 low speed will activate.

Standard Filtration/Heating Modes (F0-F3)

(Heater automatically turns on during any heat call while in any Standard mode).

- F0** 5 minutes of filtration per day (one 5 minute “Blow-Out” cycle every 24 hours to purge all plumbing lines)
- F1** 1 hour of filtration per day (one 30-minute cycle every twelve hours); this is the factory default setting.
- F2** 1.5 hours of filtration per day (one 30-minute cycle every eight hours).
- F3** 2 hours of filtration per day (one 30-minute cycle every six hours).



Economy Filtration/Heating Modes (F4-F6)

(Heater can only turn on during an active filter cycle while in any economy mode).

- F4** 1 hour of filtration/heating per day (one 30-minute cycle every twelve hours).
- F5** 1.5 hours of filtration/heating per day (one 30-minute cycle every eight hours).
- F6** 2 hours of filtration/heating per day (one 30-minute cycle every six hours).



Lock Modes (L1-L2)

- L1** Lock Out (disables all spa functions to permit filter cleaning).
- L2** Lock Mode (disables the jets and light buttons to prevent unauthorized use of spa). Filtration/heating cycle will continue to operate as programmed in this mode. The temperature display flashes when this function is enable. Example: the “F3” filtration/heating cycle was enabled prior to choosing lock mode. The spa continues to perform the “F3” cycle until lock mode is canceled, allowing another cycle to be selected.







Filter Cycle Setup Example

To set a time for the first filtration/heating cycle, simply turn power on to the spa two minutes prior to the desired time. Example: If you desire your first filtration/heating cycle to begin at 10:00 AM turn off power to the spa and turn it back on again at 9:58 AM.

Note: Start time is approximate and may vary slightly from day to day.

10.8 Programming the Circulation Pump Filtration Cycle (For Spas Equipped with a Circulation Pump)

Press and hold the **Jets pump 1** () and **Cooler** () button **at the same time** for 3 seconds to access the circulation pump programming. Continually press the **Warmer** () button to scroll up through the cycles below. Then select a cycle and press the **Jets pump 1** () button to activate that cycle. Upon pressing the jets pump 1 button the system will save your selection, exit the program menu and return to the main menu.

Note: After 10 seconds the programming screen will revert back to the temperature if no buttons are pressed. You cannot have more than one circulation pump cycle activated at a time.

[0]

0 hours of circulation per day

[1]

4 hours of circulation per day

[2]

8 hours of circulation per day

[3]

12 hours of circulation per day

[4]

16 hours of circulation per day

[5]

20 hours of circulation per day



[6]

24 hours of circulation per day (recommended factory default setting)

Note: The recommended factory default setting for the 680 Series is 24 hours. This setting should not be altered. Running the circulation pump less than the factory recommended time may result in issues with water quality maintenance.

10.9 Programming the CLEARRAY (Ultraviolet) Water Purification System

A. Programming the CLEARRAY System (U) or Corona Discharge Ozone (O3)

Press and hold the **Jets pump 1** () and **Cooler** () button **at the same time** for 3 seconds. Scroll pass the circulation pump programming menus by pressing the Warmer button, Figure 1.

Note: If your spa is not equipped with a circulation pump you will not need scroll through the circulation pump programming menus. You will enter the sanitizing system program, Figure 2.

Figure 1: Menus for spas **equipped** with a circulation pump.

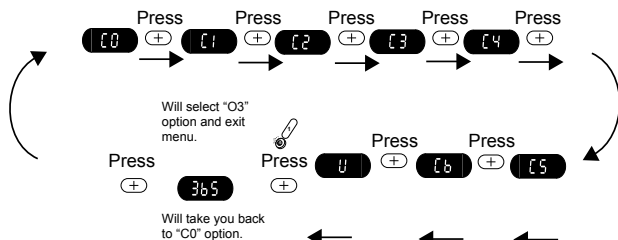

Figure 2: Menus for spas **NOT equipped** with a circulation pump.



- After the last cycle, "C6", the LED screen will display "U" or "O3." If the LED screen is displaying "U" then pressing the Jets pump 1 will change the sanitizing system from "U" to "O3" and exit the programming menu. If the LED screen is displaying "O3" then pressing the Jets pump 1 will change the sanitizing system from "O3" to "U" and exit the programming menu. You will see one of the two configurations below:

- C0, C1, C2, C3, C4, C5, C6, U, 365 (duration countdown timer)
- C0, C1, C2, C3, C4, C5, C6, O3, =

Note: For the O3 option the "=" disables the duration countdown timer.

- If you do not wish to change the option do not press any buttons and after 10 seconds the display will return to the main menu.

Note: If the CLEARRAY System has been selected, when the time allotted has expired (365 days) the display screen will flash between the water temperature and "blb." At this time the UV lamp must be replaced, the quartz tube must be cleaned and the duration countdown timer needs to be reset.





blb

B. Resetting the duration countdown timer (CLEARRAY System only)

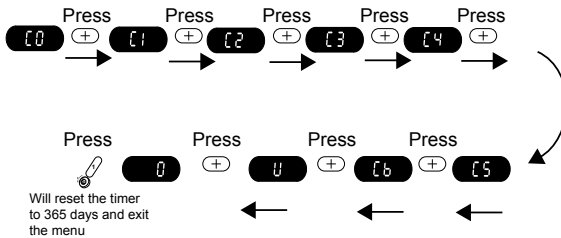
Once the duration countdown timer for the CLEARRAY System has reached zero, you will need to reset it, replace the UV lamp and clean the quartz tube.

To reset the duration countdown timer:



1. Press and hold the **Jets pump 1** () and **Cooler** () button **at the same time** for 3 seconds.
2. Press the **Warmer** () button until the display shows “0.”
3. If the timer has reached “0”, pressing the **Jets pump 1** () button will reset it. **If the timer is not at “0” pressing the Jets pump 1 button will not reset it.**

Note: If the spa power is interrupted, the duration countdown timer is not affected. The number of days remaining is stored in the memory and will continue to countdown once power is regained.

4. If the duration countdown timer is not at “0” and you need to reset it:
 - A. Press and hold the Jets pump 1 and Cooler buttons at the same time for 3 seconds.
 - B. Press the Warmer button to scroll to “U.”
 - C. Press the Jets pump 1 button to switch from “U” to “O3.”
 - D. Press and hold the Jets pump 1 and Cooler buttons at the same time for 3 seconds.
 - E. Press the Warmer button to scroll to “O3.”
 - F. Press the Jets pump 1 button to switch from “O3” to “U.” The timer has been reset to 365 days.

11.0 Spa Maintenance

Proper and regular maintenance of your spa will help it retain its beauty and performance. Your authorized Sundance dealer can supply you with all the information, supplies, and accessory products you will need to accomplish this.



DANGER: RISK OF SEVERE INJURY OR DROWNING BY ENTRAPMENT!

- Keep hair, loose articles of clothing or hanging jewelry away from suction fittings, rotating jets or other moving components to avoid entrapment that could lead to drowning or severe injury.
- Never use the spa unless all suction guards, filter, filter lid, or skimmer assembly are installed to prevent body and/or hair entrapment.
- Never operate or use the spa if the filter, filter lid, or skimmer assembly are broken or any part of the skimmer assembly is missing. Please contact your dealer or nearest service center for service.
- The suction fittings and suction covers in this spa are sized to match the specific water flow created by the pump(s). If it is necessary to replace the suction fittings, suction covers or pump(s), be sure that the flow rates are compatible and are in compliance with the VGB Safety Act page 2.
- Never replace a suction fitting or suction cover with one rated less than the flow rate marked on the original suction fitting. Using improper suction fittings or suction covers can create a body or hair suction entrapment hazard that may lead to drowning or severe injury.
- Owners must alert all spa users to the potential risk of Hair, Limb, Body, Evisceration (disembowelment), and Mechanical Entrapment, page 6.

11.1 Cleaning The Filter

⚠ DANGER: TURN POWER TO SPA OFF! TO DECREASE RISK OF DEATH, DROWNING, OR ENTRAPMENT, NEVER OPERATE SPA WHEN FILTER IS NOT PROPERLY INSTALLED OR IF SKIMMER ASSEMBLY IS DAMAGED OR ALTERED!

A. Burlington, Hartford, and Hawthorne Models:

Your spa is equipped with two filter cartridges which are utilized as follows:

- Spas equipped with the optional circulation pump use cartridge 1 for the circulation pump and cartridge 2 for jets pump 1.

To Remove: Turn
Counterclockwise

To Install: Turn
Clockwise

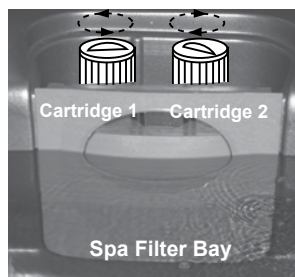

- Spas not equipped with the optional circulation pump use both filter cartridges for jets pump 1.

During spa use or an automatic filter cycle, water flows through the spa skimmer and into both polyester mesh filter cartridges to trap suspended particles and oils on their surface pleats. To ensure optimum performance, it is necessary to remove and clean both filter cartridges once a month or sooner depending on spa use and water quality.

B. Denali, Peyton and Tacoma Models:

Your Sundance spa is equipped with a skimmer basket and filter cartridge located in the skimmer/filter well. Filtering is accomplished when the pump turns on in low speed to initiate water flow through the skimmer basket and polyester mesh filter cartridge. As this happens, suspended particles become trapped on the filter's surface. To ensure optimum performance, it is necessary to remove and clean the skimmer basket once a week and filter cartridge once a month or sooner, depending on usage and water quality.

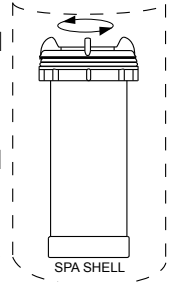

C. Cleaning Procedure (for All Models):

1. **Turn off power to the spa at the home's breaker panel or select the L1 "Lock" mode (page 30) to disable all spa functions.**
2. Remove the filter strainer lid or skimmer assembly.
3. Remove the filter cartridge by rotating it counterclockwise to unthread it from the filter wall fitting, then lift it straight up to remove from filter well.
4. Using a garden hose with a high-pressure nozzle to rinse debris from the filter pleats beginning at the top and working your way downward. Continue, one section at a time, until you have rinsed all of the filter's pleats.

Periodically, the filter cartridge will need a more thorough cleaning to remove imbedded oils and minerals. For this, we suggest cleaning as above and then soaking the cartridge overnight in a plastic container filled with a solution of water and a specially formulated filter cleanser available from your authorized Sundance dealer. The average life expectancy of a Sundance filter cartridge is approximately two years with proper care and water quality maintenance. A replacement cartridge may be purchased from your dealer.

11.2 Draining and Refilling

About every 3 months, you will want to replace the spa's water. The frequency depends on a number of variables including the amount of use, attention paid to water quality maintenance, etc. You will know it is time for a change when you cannot control sudsing and/or you can no longer get the normal feel or sparkle to the water even though the key water balance measurements are all within the proper parameters.



CAUTION! READ THIS BEFORE DRAINING: To prevent damage to the spa's components, **turn off power to the spa at the circuit breaker before draining it.** Do not turn the power back on until your spa has been refilled. There are certain precautions to keep in mind when draining your spa. If it is extremely cold, and the spa is outdoors, freezing could occur in the lines or the equipment (see "WINTERIZING", page 40). On the other hand, if it is hot outdoors, do not leave the spa's surface exposed to direct sunlight.

To drain your spa, perform the following steps (actual drain may vary from one shown). Turn off power to spa at breaker.

1. Locate and remove the synthetic cabinet door screws and door. The door is located directly below the control panel and is easily identified by it's vertical cooling slots.
2. Locate drain hose line attached to 2 x 4 wood slat (Figure A) with tie wraps.
3. Cut tie wraps and pull drain hose from equipment area (Figure B).
4. Hold drain hose above water line, then unthread drain cap (1) from hose using a counterclockwise rotation (Figure B). Place hose on ground making sure to direct water away from spa. If equipped, turn valve (2) counterclockwise to open the valve (Figure C).
5. After spa has completely drained, reinstall drain cap on drain valve finger tight! **DO NOT OVERTIGHTEN!** If equipped turn valve (2) clockwise to close the valve.
6. Place drain hose back inside the spa equipment bay.
7. Reinstall synthetic cabinet door and screws.
8. After refilling spa, turn on power and follow the "Spa Fill Up Procedure" (page 18).



Figure A

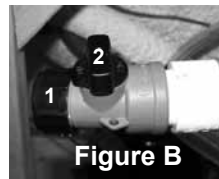

Figure B

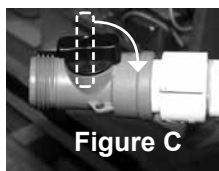

Figure C

11.3 Pillow Care (All Models Except Denali)

Remove and clean the headrest pillows as needed with soapy water using a cloth or soft-bristle brush. To maintain water resistance and luster, apply a quality vinyl conditioner once a month. Always remove the pillows when adding chemical shock treatment to the spa water. The pillows can be returned to the spa when the sanitizer reading is stable as recommended on the inside cover of the manual.

11.4 Cleaning The Spa Interior

To preserve the sheen of your spa's surface, it is crucial that you avoid using abrasive cleaners or cleaners which have adverse chemical effect

on the surface. If you are not certain as to the suitability of a particular cleanser, consult your authorized Sundance dealer. Regardless of the cleanser used, use extreme care to assure that no soap residue is left on the surface. This could cause severe sudsing when the spa is refilled.

11.5 Maintaining The Cover

Using the Sundance insulating spa cover anytime the spa is not in use will significantly reduce your operating costs, heat-up time and maintenance requirements. To prolong the life of the cover, handle it with care and clean it regularly. Below are the care instructions.

A. To Clean and Condition the Vinyl Cover

1. Use a garden hose to loosen debris and dirt.
2. Using a large sponge or a soft bristle brush, use diluted or mild soap and scrub the vinyl top. Rinse clean and do not allow soap to dry on cover. Do not use soap on the underside of the cover.
3. Please check with your Sundance Spa Dealer for recommended cover care and conditioning products. Condition using non-petroleum based conditioners to keep the vinyl supple and threads/stitching from drying out. Do not use solvents, abrasive cleaners or strong detergents. Do not use products that contain silicone or alcohol.

B. Additional Care and Maintenance Instructions:

1. Debris can accumulate on the spa cover. Removal of snow or other debris will help to avoid breakage of the foam cores.
2. Be sure to lock the cover straps to secure the cover from unwanted or accidental entry.
3. Do not place heavy objects on the vinyl.
4. Do not walk, sit or stand on the cover.
5. Do not drag or use the flaps/skirt or the cover lock straps to remove the cover.
6. Use only recommended cover lift systems.
7. Use only chemicals and cleaners recommended by Sundance Spas.
8. Remember to keep spa covered when not in use. Maintaining proper water levels assures efficient operation and efficient electrical usage.
9. Do not expose your spa to the sun for extended periods of time as UV rays can damage the interior surface.
10. Use caution when removing cover. Before removing cover, assure all locks have been released to avoid lock breakage and or cover strap damage.

11.6 Maintaining The Synthetic Cabinet

Your new spa's synthetic cabinet requires little or no maintenance of any kind. To clean, simply wipe cabinet with a clean towel and mild soap solution.



CAUTION: Never spray cabinet with a garden hose for any reason since this action may induce an electrical short in the spa's electrical equipment.

11.7 Winterizing

Your Sundance® spa is designed to automatically protect itself against freezing when operating properly. During periods of severe freezing temperatures, you should check periodically to be certain that the electrical supply to the spa has not been interrupted. In extreme, bitter cold weather less than -20°F (-29°C), choose the F3 “Standard” filtration/heating mode to prevent freezing (pages 31-32).

If you do not intend to use your spa, or if there is a prolonged power outage during periods of severe freezing temperatures, **it is important that all water be removed from the spa and equipment to protect against damage from freezing.**

Expert winterization of your spa is highly recommended, contact your authorized Sundance dealer. In emergency situations, damage can be minimized by taking the following steps:

CAUTION: TURN OFF POWER TO HOT TUB!
--

1. Turn off power to the spa.
2. Follow the directions on page 37 for draining the spa.
3. Turn the massage/diverter selector(s) into the middle combo position to allow the water in the plumbing lines to drain, see page 29.
4. Turn the waterfall valve to the open position to allow the water in the plumbing lines to drain, see page 29.
5. As the water level drops below the seats, use whatever means necessary to get the water out of the recessed seating areas and into the footwell, such as a wet/dry vacuum.
6. When the water level ceases to drop, use whatever means available to remove any remaining water from the footwell, such as a wet/dry vacuum.
7. Remove the equipment-side cabinet panel and locate the drain plugs in the front of the pump(s) (Figure A, page 16). Remove these plugs to allow the water to drain out of the pumps and heater.

Note: Approximately one to two gallons will be released during this procedure. Use a wet/dry vacuum or other means to keep this from flooding the equipment compartment. Replace the pump drain plugs.

8. Loosen hose clamp at bottom of CLEARRAY™ system and pull hose off of CLEARRAY fitting (twist the hose back and forth while pulling downward). Tip hose down and allow to drain, then reinstall hose and clamp. Remove the cover of the CLEARRAY system to access the UV lamp and quartz tube. Remove and store the UV lamp in a safe location. Remove and dry off the quartz tube then reinstall it. Depending on the length of time, consider replacing the UV lamp when you resume use of your hot tub.
9. Re-install cabinet side panels and cover spa so that no casual moisture can enter into it.

Consult your authorized Sundance dealer if you have any questions regarding winter use or winterizing.

11.8 Restarting Your Spa in Cold Weather

If you want to start up your spa after it has sat empty for a time in freezing temperatures, be aware that the water remaining in certain sections of the piping may still be frozen. This situation will block water flow preventing the spa from operating properly and possibly damaging the equipment. We recommend you consult your authorized Sundance dealer for guidance before attempting to re-start your spa under these conditions.

12.0 Water Quality Maintenance

To decrease the risk of contracting a waterborne illness (e.g. an infection, bacteria or virus) and/or respiratory ailments, maintain water quality within specified limits. This will enhance your enjoyment and prolong the life of the hot tub's equipment. Doing so requires regular attention because the water chemistry involved is a balance of several factors. Procrastination in regard to water maintenance will result in poor and potentially unhealthful conditions for soaking and even damage to your hot tub investment. For specific guidance on maintaining water quality, consult your Authorized Sundance Spas dealer who can recommend appropriate chemical products for sanitizing and maintaining your hot tub.



WARNING: FAILURE TO MAINTAIN WATER QUALITY WILL:

- Increase risk of contracting a waterborne illness (e.g. an infection bacteria or virus) and/or respiratory ailments.
- Damage the equipment, components and spa shell, which are not covered under the hot tub's warranty.

CAUTION: Never store hot tub chemicals inside the hot tub's equipment bay. The equipment bay may reach elevated temperatures, this is where high voltage electronic devices are located. This area is not intended for storage of any kind.

12.1 pH Control

pH is a measure of relative acidity or alkalinity of water and is measured on a scale of 0 to 14. The midpoint of 7 is said to be neutral, above which is alkaline and below which is acidic. In spa water, it is very important to maintain a slightly alkaline condition of 7.4 to 7.6 pH. Problems become proportionately severe the further outside of this range the water gets. A low pH will be corrosive to metals in the spa equipment. A high pH will cause minerals to deposit on the interior surface (scaling). In addition, the ability of the sanitation agents to keep the spa clean is severely affected as the pH moves beyond the ideal range. That is why almost all spa water test kits contain a measure for pH as well as sanitizer.

12.2 Sanitizing

To destroy bacteria and organic compounds in the spa water, a sanitizer must be used regularly. Chlorine and bromine are the two most popular sanitizers used to date. Many other additives are available for your spa. Some are necessary to compensate for out-of-balance water; some aid in cosmetic water treatment and others simply alter the feel or smell of the water. Your authorized Sundance dealer can advise you on the use of these additives. When adding spa shock (chlorine or non-chlorine) or pH balancing chemicals activate the jets pump(s) and leave the spa cover open for a minimum of 20 minutes. By doing this you will allow excessive chemical vapors to exit the spa, protecting pillows and plastic knobs from chemical attack.



WARNING: RISK OF PERSONAL INJURY, DROWNING OR ENTRAPMENT!

Never leave your hot tub unattended for any reason while the cover is open and accessible, especially to small children and animals!

CAUTION: RISK OF PERSONAL INJURY OR SPA DAMAGE!

Never add chlorine tablets (trichlor) or acid to your hot tub for any reason! These chemicals may damage components within your hot tub, burn or irritate your skin, create a rash and void the manufacturer warranty for your spa.

12.3 CLEARRAY™ Water Purification System

Your new hot tub has our water purification system factory installed that will begin disinfecting your water instantly.

CLEARRAY Water Purification System is exclusive technology utilizing natural ultraviolet technology to sanitize your water, disinfecting bacteria, viruses, and algae in portable hot tubs. The ultraviolet light otherwise known as UV-C or germicidal light inactivates the microorganisms by disrupting the DNA so that it cannot reproduce and is considered lifeless. The ballast is the power supply for the purification system; it has two LED indicator lights the green indicating incoming power flow and the red indicating the system is properly working. CLEARRAY is standard for all models.

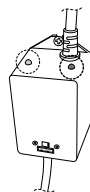
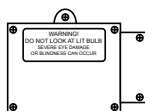

- **(For models with a circulation pump):** The CLEARRAY System only runs when the circulation pump is running and shuts off when either jets pump is manually activated during spa use. The system will remain off for 5 minutes after both jets pumps time out or are manually turned off, then resume operations if the circulation pump is programmed to run.
- **(For models without a circulation pump):** The CLEARRAY System only runs when the jets pump 1 is running.

After a year the lamp must be replaced. If the UV timer has been programmed correctly a message will appear on the LED display when the time allotted has expired. In order to clear the “blb” message a new UV lamp needs to be installed and the timer must be reset (Section 10.9, page 34).

Note: In order to access the CLEARRAY unit, the front synthetic panel or the stereo panel and the right corner panel need to be removed.

12.4 CLEARRAY™ Lamp Replacement and Quartz Tube Maintenance

Important: It is **MANDATORY** that the UV lamp is replaced and the quartz tube be cleaned every 12 months to maintain optimum performance.

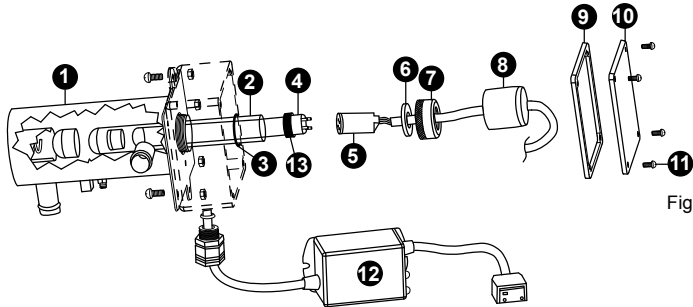

Figure 1



DANGER: TURN THE SPA BREAKER TO THE OFF POSITION!



WARNING: ALLOW LAMP TO COOL DOWN PRIOR TO REMOVING FROM QUARTZ TUBE.



DANGER: NEVER LOOK AT THE LIT BULB. THIS CAN CAUSE SEVERE EYE DAMAGE OR BLINDNESS.

UV lamp replacement and quartz tube maintenance:

Note: Location of CLEARRAY System and connection may vary by model.

1. Turn the breaker to the spa OFF. We recommend that you drain your spa. Disconnect the CLEARRAY System from the controller, Figure 2.
2. Once the UV lamp has cooled off remove the CLEARRAY System enclosure cover (10) and gasket (9) by removing the four screws (11).

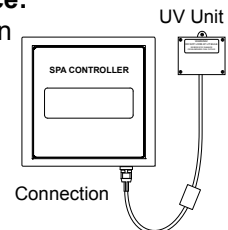

Figure 2



DANGER: NEVER REMOVE COVER WITHOUT FIRST TURNING OFF AT POWER SOURCE.

Figure 3

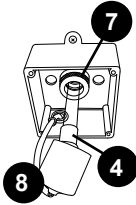

Figure 4

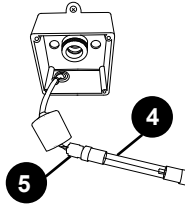
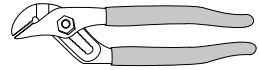

Figure 5



3. Remove the black lamp boot (8) by sliding it over the cable away from the quartz seal compression nut (7), Figure 3.
4. Slowly remove the UV lamp (4) out of the quartz tube.
5. Remove lamp socket (5) from the UV lamp (4), Figure 4.
6. Remove the quartz seal compression nut (7) by turning it **counterclockwise**, Figure 3. Use a pair of channel-lock pliers if needed, Figure 5. You will notice that there is a stainless steel compression washer (6) that slides over the quartz tube. Save the washer (6) for later use, Figure 6. There is also a black seal ring (13), grasp the black seal ring; slowly and carefully remove the quartz tube.

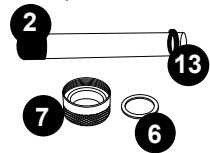

Figure 6

7. Now you are ready to clean or replace the quartz tube (2). For the cleaning of the quartz tube (2), follow steps 8 and 9 then proceed to step 10. For replacing of the quartz tube (2), skip steps 8 and 9 and proceed to step 10.
8. **Cleaning quartz tube:** Clean the quartz tube by wiping until clear using a paper towel or a dry cotton cloth. If needed a household tub and shower lime removal product can be used.



WARNING: Do not use abrasive cleaners as they can scratch the quartz tube surface.

9. Rinse the quartz tube with clean water to completely remove any cleaning products that were used in step 4.
10. **Replacing quartz tube:** You will notice that the new quartz tube does not have a black cushion on the domed end as the old quartz tube does. This is normal as the cushion was provided with the original quartz tube to protect it from breakage during transportation. Install the black seal ring (13) over the opened end of the quartz tube. Place the new quartz tube (2) into the water chamber (1) with the domed end first making sure it is inserted and seated inside the quartz end holder. Only a small portion will be exposed when it is seated correctly.

11. Reinstall the compression washer (6) over the open end of the quartz tube (2). Push it against the quartz black seal ring (13).
12. Reinstall and hand tighten the quartz seal compression nut (7) by turning it **clockwise**.
13. Refill your spa.
14. **System Test 1:** Assure there is no water dripping from the seal compression nut (7). If water is visible, STOP and tighten the compression nut (7) using a pair of channel lock pliers to a maximum of 1/4 turn. If that does not fix the leak, then repeat quartz tube maintenance process from step 1 through step 13. Make sure there is no water leaking before proceeding to step 15.
15. **System Test 2:** Turn breaker back ON. Turn on the pump to circulate the water through the CLEARRAY System. Wait for 5 minutes and assure no water is dripping. If water is visible, STOP, fix the leak by repeating quartz tube maintenance process from step 1 through step 14. **Make sure there is no water visible and turn the pump and breaker OFF BEFORE proceeding to step 16.**
16. Reconnect the lamp socket (5) to the new UV lamp (4) make sure you use the latex glove provided when handling the UV lamp.

Note: Align pins on UV lamp (4) to the receptacle holes on the lamp socket (5) before inserting the pins completely into socket holes. Failure to do so will damage the UV lamp.



WARNING: DO NOT TOUCH THE NEW UV LAMP WITH YOUR BARE HAND. Oil on your skin will cause hot spot on the UV lamp and shorten the life of your UV lamp. Use the provided latex glove to handle the UV lamp.

17. Slide the new UV lamp (4) back inside the quartz tube, Figure 3.
18. Reinstall the black lamp boot (8) back over the quartz seal compression nut (7).
19. Reinstall the enclosure cover (10) with gasket (9) and secure with the screws.
20. Reconnect the CLEARRAY System to the controller and turn on the power to the spa.
21. Properly dispose of the old UV lamp.



WARNING: This CLEARRAY System includes a UV lamp, which contains mercury. Dispose of the lamp in accordance with disposal laws. See www.lamprecycle.org.

22. Once power is activated you can check the ballast (12), Figure 7, to see if the CLEARRAY System is functioning. A solid green light indicates that the CLEARRAY System is being provided power and should always be on. A solid red light indicates that UV lamp is activated.

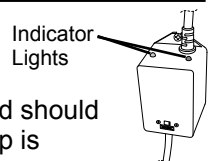

Figure 7

13.0 Error Conditions/Error Messages

Your spa has a self-diagnostic control system. The system will automatically display the following if a problem is detected. **Always insist on genuine Sundance replacement parts.**

13.1 Summer Logic (Spas With Circulation Pump Option)

When the actual spa water temperature reaches up to 2°F (1°C) above the set temperature, the spa goes into “summer logic.” The circulation pump will turn off automatically, if running, to avoid adding additional heat to the water, eventually creating an overheat condition. This setting is not user-programmable.



Note: The summer logic does not take effect until the spa water temperature reaches 95°F (35°C). This condition is more likely in excessively hot weather. Remember, the spa’s ability to cool is directly affected by the ambient temperature. An excessively hot ambient temperature may prevent the spa from cooling down because it’s fully insulated construction is designed to retain heat and to minimize operating costs.

13.2 Panel Displays SN1

Open sensor (heater is disabled) or shorted sensor (spa is deactivated). The high-limit temperature sensor is not functioning. Your authorized Sundance dealer must repair this.

13.3 Panel Displays SN2

Open or shorted sensor (heater disabled). The temperature sensor is not functioning. Your authorized Sundance dealer must repair this.

13.4 Panel Flashes FL1 or FL2 (Spas Without Circulation Pump Option)

A flashing “FL1” display means the pressure switch is not closed when the jets pump 1 is activated. Proper water flow is inhibited or the pressure switch has malfunctioned. A flashing “FL2” display means the pressure switch is malfunctioning closed. In either case, the heater is deactivated. To correct condition, perform to the following:

1. Verify water level is one inch below lowest pillow. Add water if necessary.
2. Check for clogged or excessively dirty filter cartridges (Section 11.1, page 36).
3. Purge “air lock” from jets pump 1 by loosening the upper pump head drain screw (Figure A, page 16) for a few seconds to release trapped air, then retighten drain screw. FINGER TIGHT ONLY!
4. If problem persists, contact your authorized Sundance dealer.

13.5 Panel Flashes FL1 or FL2 (Spas With Circulation Pump Option)

A flashing "FL1" display means the flow switch is malfunctioning open, the circulation pump filter cartridge 1 is excessively dirty or an "air lock" condition has occurred at the circulation pump intake. A flashing "FL2" display means the flow switch is malfunctioning closed. In either case, the spa heater will deactivate and jets pump #1 may also deactivate. To correct condition perform the following:



1. Verify water level is 1" below lowest pillow. Add water if necessary.
2. Check for clogged or excessively dirty filter cartridges (Section 11.1, page 36).
3. Purge "air lock" from circulation pump intake by removing filter cartridge 1 (page 36). Hold your garden hose over the filter cartridge 1 wall fitting (with grate) while using a rag as a seal around hose end. Ask a helper to turn on water for 30 seconds, then turn off. Reinstall filter cartridge 1 and check spa (Section 11.1, page 36).
4. If the circulation pump is not running, turn power off at the main breaker, then turn power back on. This will reset the circulation pump priming cycle. Once the pump is primed, the error should clear.
5. If problem persists, contact your authorized Sundance dealer.

13.6 Panel Displays COL

Cool Condition - Temperature has dropped 20°F (11°C) below the current set temperature. The pump and heater have been activated to bring the temperature to within 15°F (8°C) of the set temperature. No corrective action is required.

Note: During cold periods, you may consider increasing the number of filtration cycles (pages 31-32).

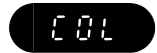

13.7 Panel Displays ICE

Freeze Protection - A potential freeze condition has been detected. No action is required. The pump and heater will operate to circulate and warm water through the plumbing spa is out of danger. See "Winterizing" Section 11.7 for details (page 40).



13.8 Panel Displays OH



WARNING: RISK OF HYPERTHERMIA (OVER-HEATING) CAUSING SEVERE INJURY, BURNS, OR WELTS.



Water temperature is above acceptable limits. **DO NOT ENTER SPA!** Water temperature has reached 112°F (44°C) and the low speed pump has activated to circulate water through heater.

13.9 Panel Displays - - -



WARNING: RISK OF HYPERTHERMIA (OVER-HEATING) CAUSING SEVERE INJURY, BURNS, OR WELTS.

- - -

Water temperature is above acceptable limits. **DO NOT ENTER SPA!** The safety “Watchdog” software has been triggered and the spa is deactivated. A problem has been detected which could cause damage to the spa or its components. Contact your authorized Sundance dealer.

13.10 Panel Displays BLB

UV lamp needs to be replaced. The message will flash between “blb” and the water temperature. The timer for the UV lamp must also be reset, refer to Section 10.9, page 34. A new UV lamp can be purchased from a local Sundance Spas dealer.

blb

14.0 Troubleshooting Procedures

In the event your spa is not working the way it should, please first review all the installation and operating instructions in this manual and check the message on the panel display. If you are still not satisfied it is working properly, please follow the appropriate troubleshooting instructions below.

Note: If any of the supply cords to the accessories are damaged, they must be replaced by authorized service personnel.

14.1 None of the Components Operate (e.g. Pump, Light)

Check the following when none of the spa components operate (e.g. jets pumps or light):

1. Is there power to the spa?
2. Is the household circuit breaker tripped?
3. Call your authorized dealer.

14.2 Pump Does Not Operate but Light Does

Press the JETS 1 Button:

1. If no water movement is detected, make sure power is going to the spa and check the water level. If it does not solve the problem, contact your authorized Sundance dealer.
2. The main pump operates but no water flows to jets. Pump may not be properly primed. This can happen after the spa is drained and refilled.
 - A. Press the JETS 1 button several times, never leaving the motor on for more than 5 to 10 seconds at a time. Turn power off and let the air out removing the filter cartridge. Refer to Section 11.1 (page 36). Make certain you reinstall the filter cartridge before turning on spa power and restarting the jets pump.

14.3 Poor Jet Action

1. Press the JETS 1 button to make certain the pump #1 is on.
2. Open all air control to the "on" position.
3. Check for dirty filter. Clean, if necessary.
4. Make sure jets are all the way open.

14.4 Water is Too Hot

Reduce thermostat setting.

14.5 No Heat

1. Check thermostat setting.
2. Keep the spa cover in place while heating.
3. Check the settings to see if your spa is in economy filtration/heating mode (pages 31-32).

Should checking the above steps fail to correct the problem, please call your dealer so that they may arrange service.

We build the best spas in the industry. Nonetheless, we are always striving to improve the quality and features of our products. Your input as a Sundance spa owner is a cherished part of this process. If you have any comments or suggestions, or if you wish to be informed on any new products for your spa, please write to us.

CONGRATULATIONS on your good taste and welcome to the happiest and most relaxed family in the world!

15.0 North American Denali/Tacoma Convertible Circuit Diagram (60 Hz)

This wiring diagram is used for all North American Denali/Tacoma 120/240 VAC (60 Hz) convertible power models.

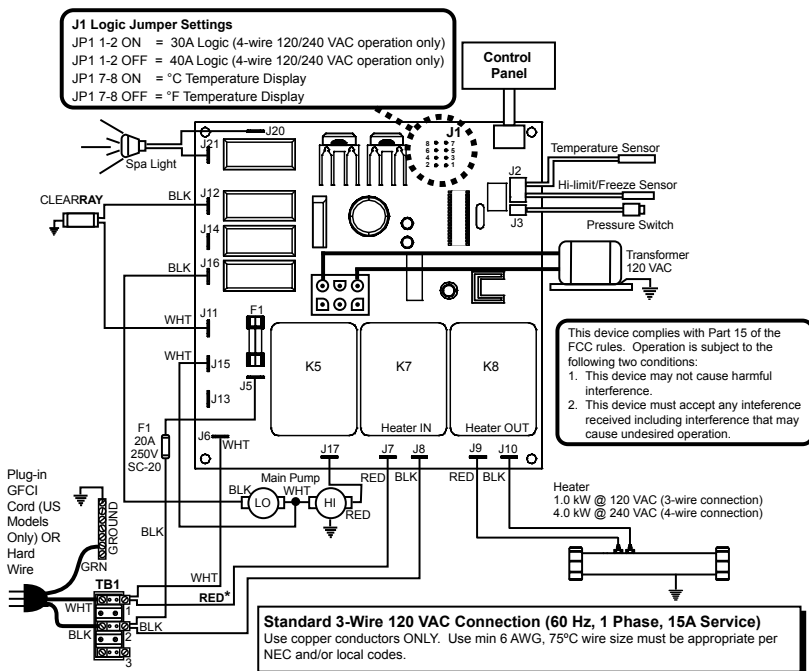

WARNING, ELECTRICAL SHOCK HAZARD EXISTS! Always remove power to spa before wiring and/or configuring the circuit board

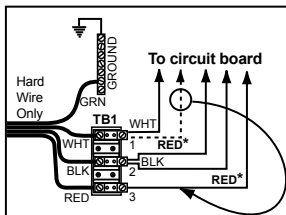

Optional 4-Wire 240/120 VAC Convertible Heater Connection

1. Remove and discard the factory installed GFCI Cord.
2. Move RED* wire from TB1 position #1 to TB1 position #3 as shown below.
3. Permanently connect to the power supply. Use copper conductors ONLY. Wire size must be appropriate per NEC and/or local codes.
4. If hot tub is to be operated on 30A service, make sure the jumper provided at location JP1 #1 & 2 on the circuit board is installed. If hot tub is to be operated on 40A service, remove the jumper JP1 #1 & 2 on the circuit board.

EXTERNAL SERVICE PANEL
BOX DISCONNECT MEANS
MUST BE LOCATED NO CLOSER
THAN 5 FT. (1.52m) FROM THE
INSIDE WALLS OF THE SPA AND
WITHIN SIGHT OF SPA

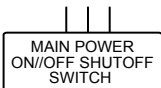

16.0 North American Burlington Circuit Diagram (60 Hz)

This wiring diagram is used for all North American Burlington models with or without the circulation pump option. (Circuit board diagram is shown with the circulation pump option.)

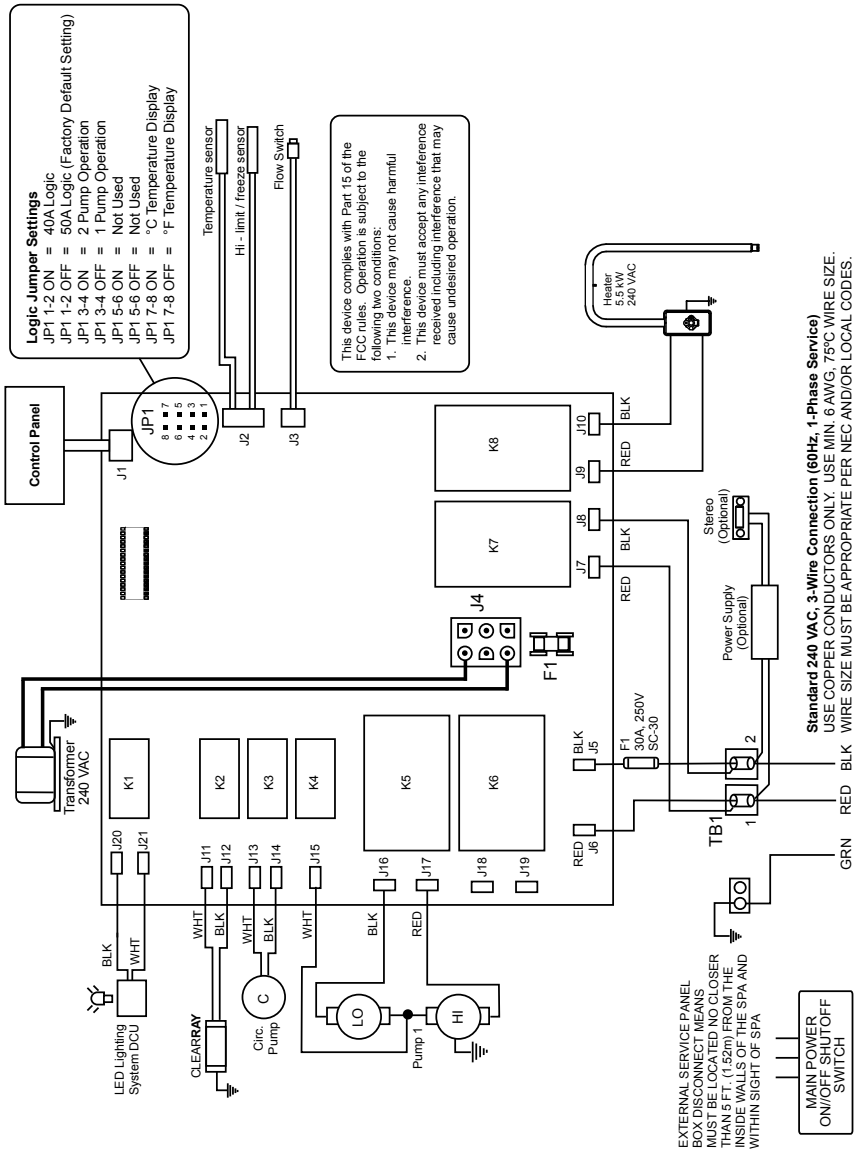

17.0 North American Peyton Circuit Diagram (60 Hz)

This wiring diagram is used for all North American Peyton models.

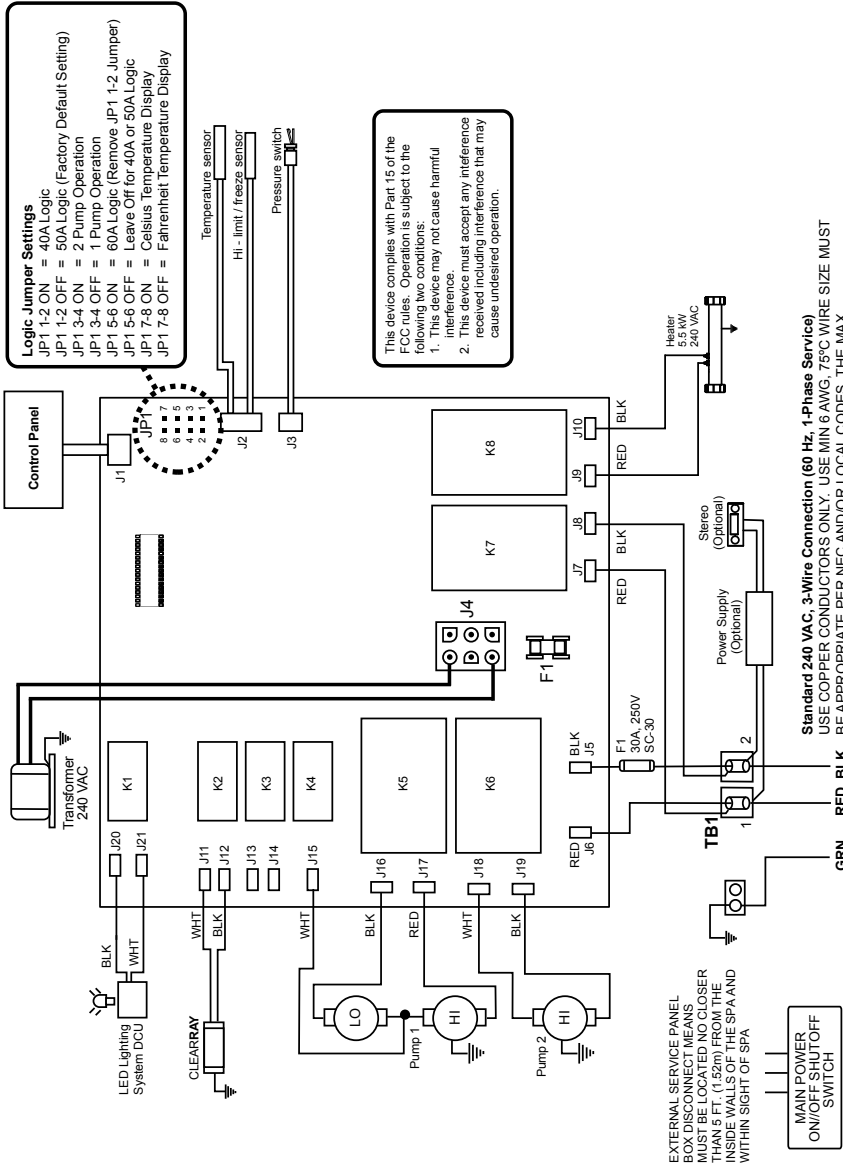

18.0 North American Hartford and Hawthorne Models (60 Hz)

This wiring diagram is used for all North American Hartford and Hawthorne with or without the circulation pump option. (Circuit board diagram is shown with the circulation pump option.)

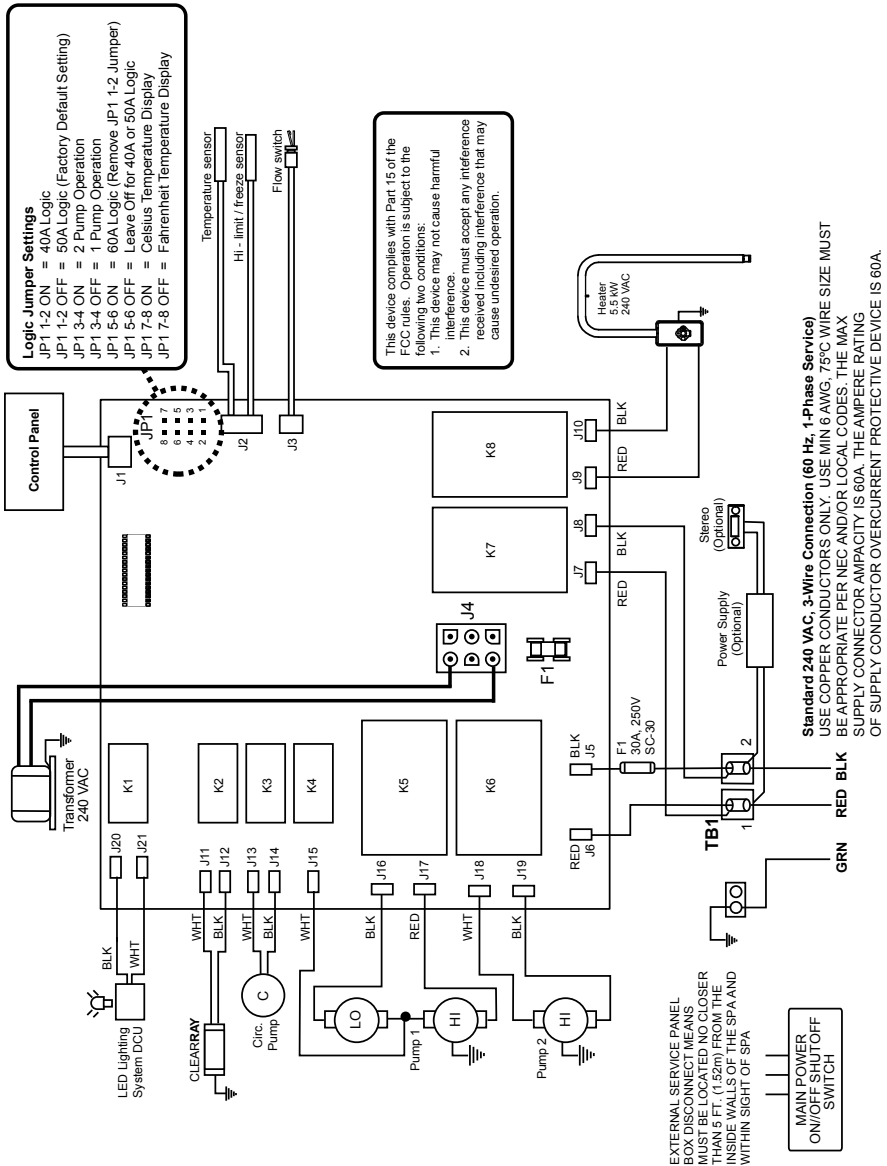

19.0 Export Denali/Tacoma Circuit Diagram (50 Hz)

This wiring diagram is used for all Export Denali/Tacoma models.

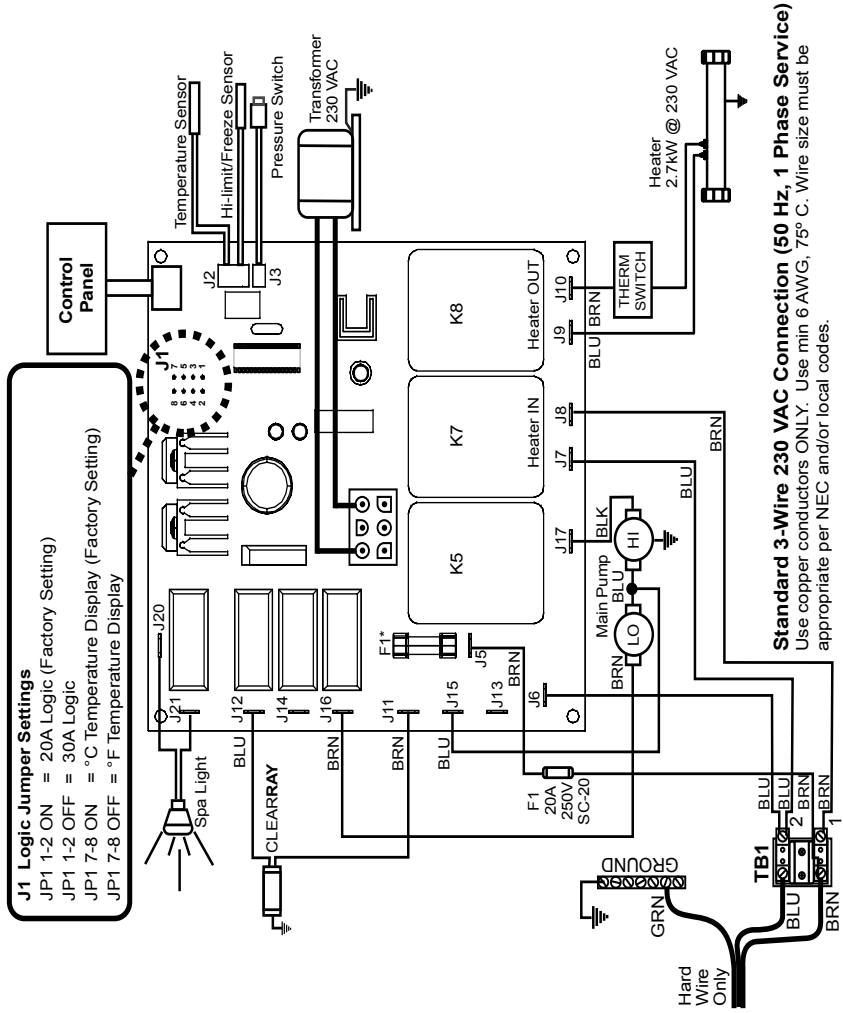

20.0 Export Burlington Circuit Diagram (50 Hz)

This wiring diagram is used for all Export Burlington models with or without the circulation pump option. (Circuit board diagram is shown with the circulation pump option.)

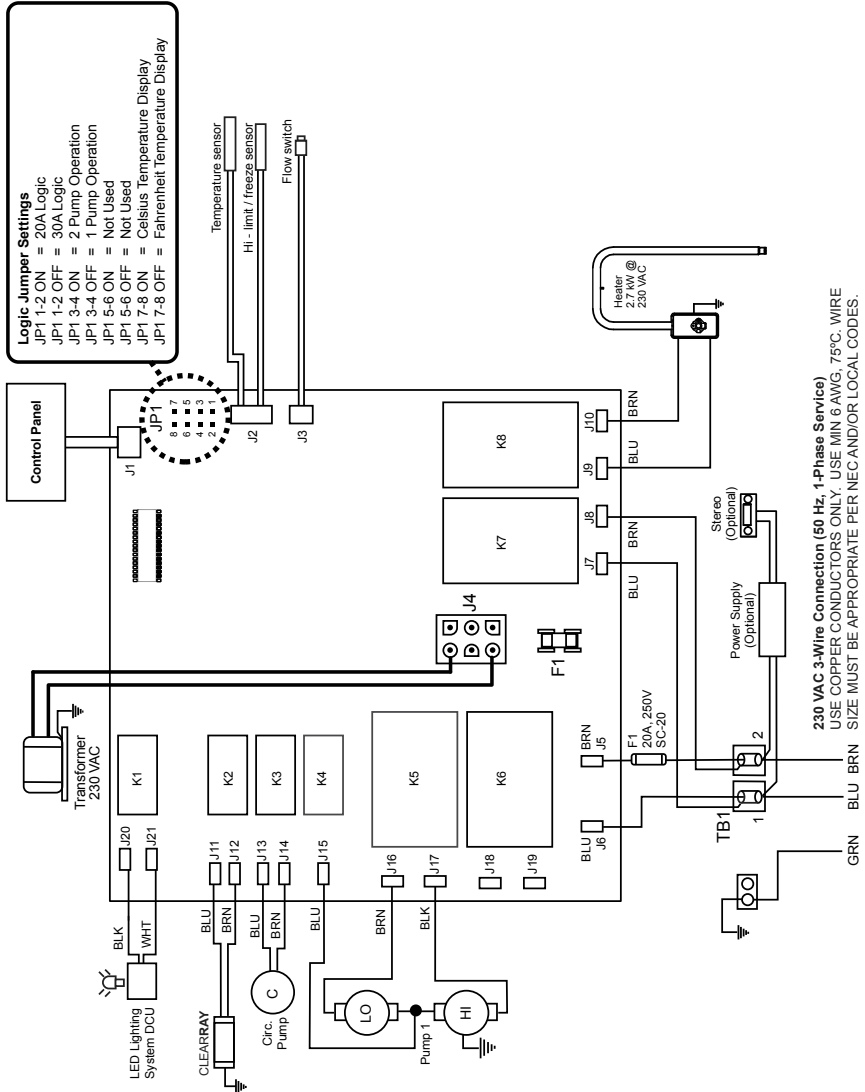

21.0 Export Peyton Circuit Diagram (50 Hz)

This wiring diagram is used for all Export Peyton models.

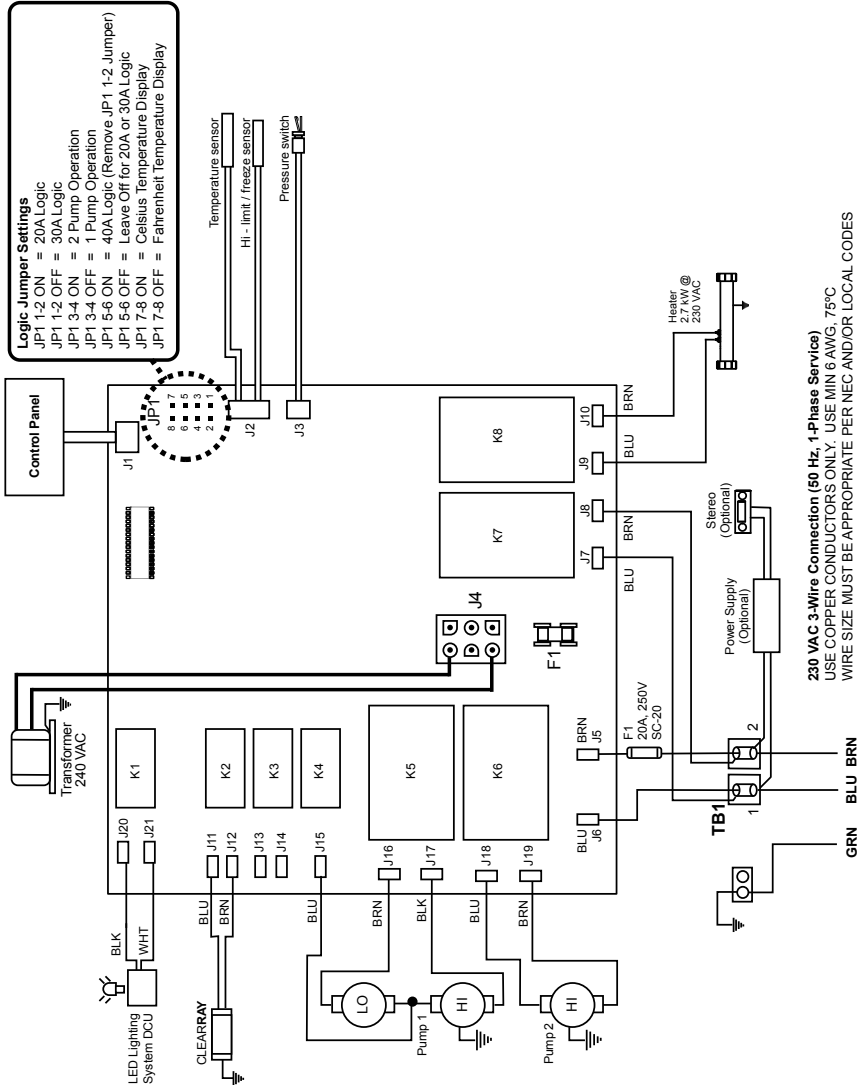

22.0 Export Hartford and Hawthorne Circuit Diagram (50 Hz)

This wiring diagram is used for all Export Hartford and Hawthorne models with or without the circulation pump option. (Circuit board diagram is shown with the circulation pump option.)

